

STAINLESS STEEL GREENERY SYSTEMS

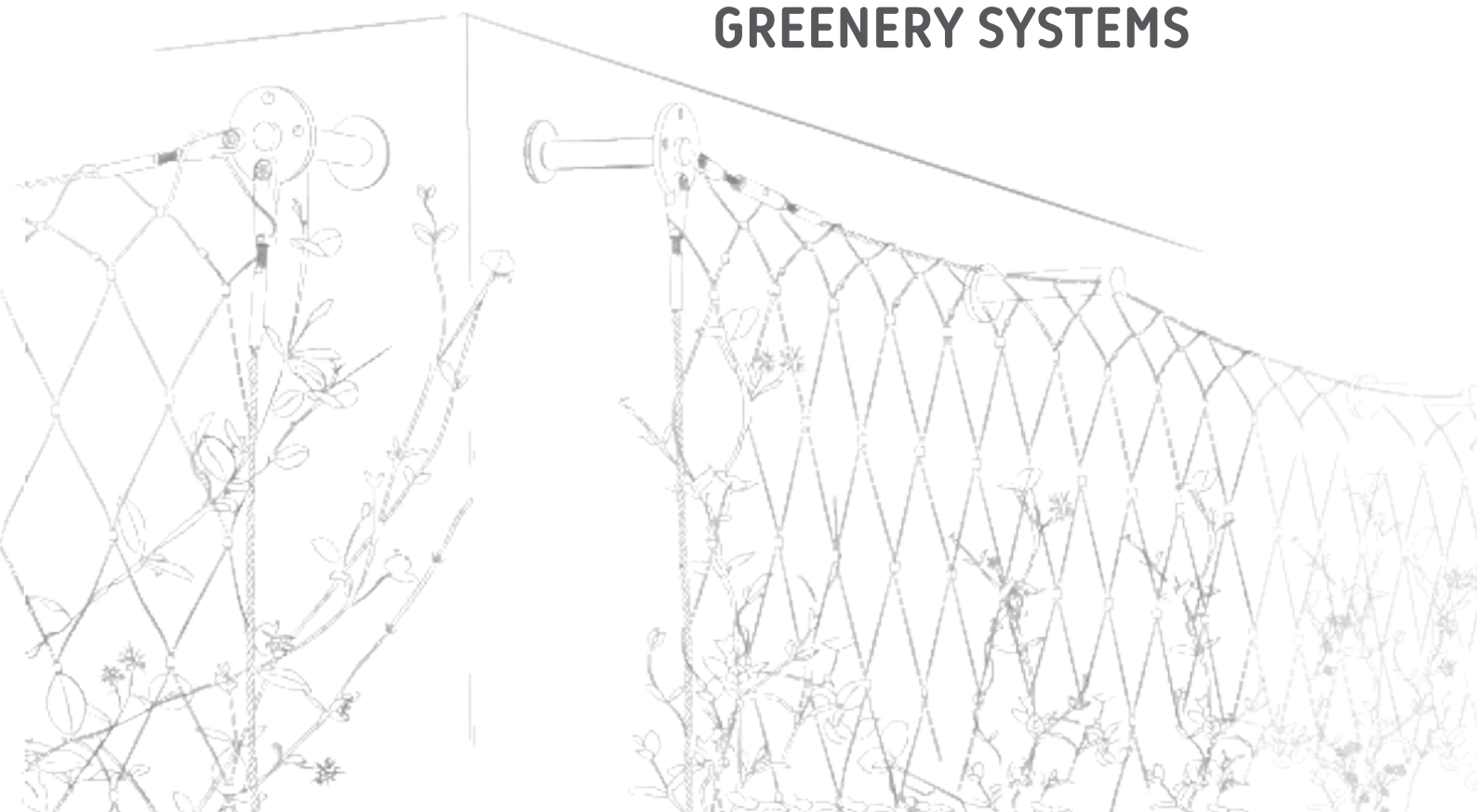



CONTENT	PAGE
• Who we are ?	
Our Company	-4-
• What we do ?	
Consulting	-5-
Planning & Design	-6-
Static Calculations	-7-
Production	-7-
Installation	-8/9-
• GREENERY Systems	
Greenery Systems Designing & Planning	-13-
I-NET Greenery Systems	-14/15-
- System with Frame	-16-
- System with I-ROPE	-18-
Greenery Accessories	-24/25-
Greenery System Installation Examples	-26/27-
• Characteristics Of Wire Ropes	
Explanation & Application of Wire Ropes	-28/29-
Technical Information about Wire Ropes	-30-
• Overview Of Stainless Steel	
Material	-32-
Corrosion	-34-
Maintenance & Cleaning	-35-
• Technical Tips	
Rope Forces & Tensioning	-36-
Tightening & Loosening Description of Rope System	-36-
• Assembly Lengths	-37-
• Our Goals	-39-



- **Who we are ?**

INOX-NET is a young and dynamic company specializing in architectural stainless steel net and rope systems. Our aim is to provide innovative, cost-effective, environmentally friendly, and long-lasting products with excellent quality. Stainless Steel Net and Rope Systems provide suitable solutions for many types of architectural projects by their features such as flexibility, durability, high quality, and lightweight.

INOX-NET is interested to be your solution partner from the smallest volume individual projects to the most unique and challenging projects from all over the world.

Our Company ;

INOX-NET is experienced in architectural applications involving stainless steel net and rope systems. We provide services and solutions in many architectural projects ranging from balustrades, safety nets, facades, greenery, decoration and zoo enclosures.

- **What we do ?**

INOX-NET provides A to Z services from consulting, design and planning, static calculations to production and installation for customers all over the world who want to give life to their innovative ideas and imaginations.

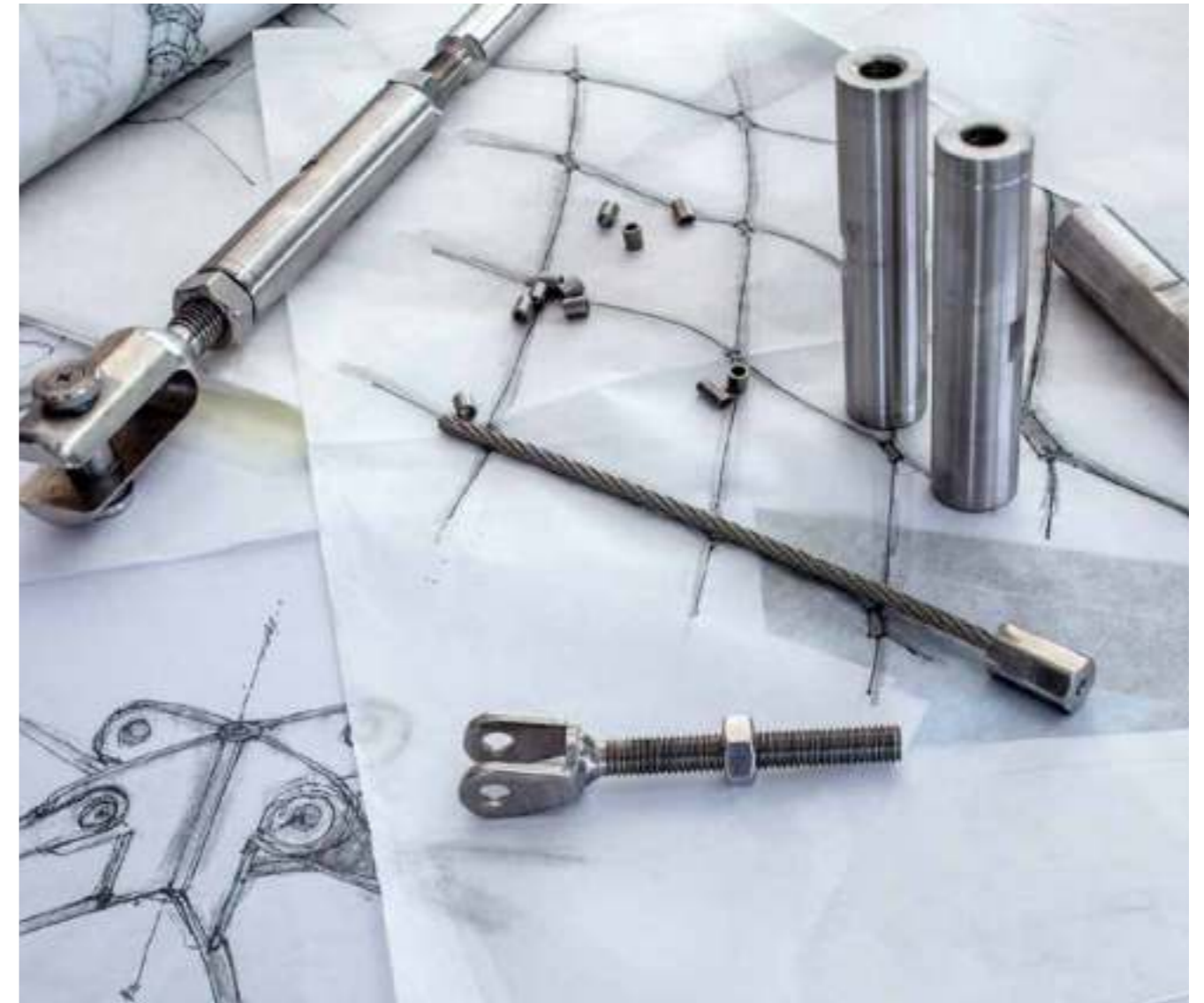

Consulting ;

We provide consultancy services to architects, architectural design offices and contractors to fulfill their needs and guide their imagination. The consulting service we provide begins from the first idea of the architectural design project and lasts through the planning stage to the realization stage. We are always happy to share our ideas with you whether through phone, via email, or if you like face to face in our offices.

Planning & Design

The INOX-NET planning process includes:

- **DESIGN AND SYSTEM DEVELOPMENT,**
- **PLANNING SUPPORT,**
- **ADMINISTRATIVE PLANNING,**
- **PROJECT APPLICATION FOR ROPES, NETS AND STEEL WORKS,**
- **INSTALLATION PLANNING.**

INOX-NET services are always customer focused and our specialists are actively involved in the whole process from the beginning. Besides providing standard products, INOX-NET also provides custom design stainless steel net and stainless steel rope application concepts if so desired.



Static Calculations

INOX-NET can perform structural static calculations for all kinds of stainless steel net and rope projects when needed.

Our static analysis services are:

- **SYSTEM DEVELOPMENT,**
- **SHAPING OF STAINLESS STEEL NETS AND NET STRUCTURES,**
- **SIZING OF NET AND ROPE LOADS,**
- **CALCULATION OF ADDITIONAL COSTS,**
- **VERIFIABLE STRUCTURAL STATIC CALCULATIONS.**

Production

After approval of the production drawings, they are delivered to the production department and productions start immediately according to these plans. Each net part is produced according to the desired measurements, diamond direction, and net ending features. I-ROPE systems are also produced by taking attention to the pin to pin measurements and pre-tension loads resulting from the static calculations.

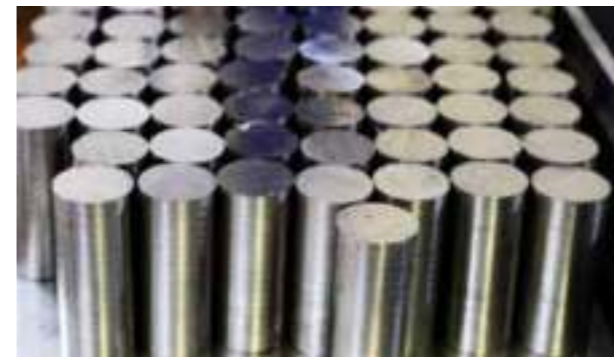

Installation

- Self-Assembly by the customer,
- Installation training,
- Installation support.
- Installation supervision,
- Turn-key installation by INOX-NET.

According to customer preference, INOX-NET Stainless Steel Ropes and Net Systems can be installed on site by our experienced installation team.

Stainless, Ageless, Elegant, Durable, Solid & Transparent.

Istanbul 3.rd Airport I-ROPE Installation

BEHIND EVERY INNOVATIVE PRODUCT

THERE IS A CREATIVE SOLUTION.

GREENERY SYSTEMS



GREENERY SYSTEMS

In recent years vertical greenery systems have become more popular and increased their presence in building design.

Providing better air quality, noise damping, increasing thermal insulation, and visual enhancement of the building profile are some of the benefits which make the green wall systems a great choice.

Stainless steel rope and net systems are the most long-life and low maintenance systems offering flexibility to suit a variety of plant species and wind loads. Stainless Steel Net Systems provide additional options, with closer weaves than horizontal and vertical cabling.

I-NET and I-ROPE greenery systems are very flexible, cost effective and environmentally friendly systems with easy planning and installation abilities. There are many factors to consider about choosing the correct greenery system such as, plant growth, load, grid structure, distance from wall and height.

Grid Structure: The type and growth size of the plant determines the grid structure.

Height: It is important that plant growth height does not exceed the height of the greenery system.



















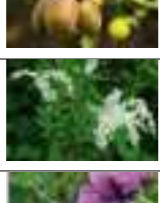



Distance From Wall: The distance from the wall depends on the growth density and root style of the plant.

Load: Depends on the climate factors such as rain, snow, wind loads and the plant factors such as wood and fruit weight.

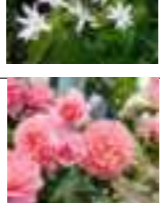
Plant Growth: The type of plant, plant root style and growth rate are important to choose the right system.

DESIGN AND PLANNING OF THE GREENERY SYSTEMS SHOULD BE DONE BY CONSIDERING THE IMPORTANT FACTORS WITH AN EXPERT.

GREENERY SYSTEM DESIGNING AND PLANING

Plant type	Plant name	Plant picture	Growing height (m)	Systems	Sytems's width & heights (mm)	Distance from wall(mm)
Vines (Twinning plants)	Wisteria		3-10	      	<p>System 1 Width :max.1500 Heigth: max.2000</p> <p>System 2 Width: max.1500 Heigth: max.2000</p> <p>System 3/ 4 / 6 / 7 / 8 Width :min.300 - max800 Heigth : min.300 - max2000</p>	90-150
	Lonicera (honeysuckles)		3-8			
	Actinida (kiwi)		4-9			
	Fallopia		2-12			
	Five leaf akebia		4-12			
Climbers	Ampelopsis		3-8	   	<p>System 3 / 4 / 7 / 8 Width : min.300 - max800 Heigth : min.300 - max2000</p>	90-150
	Passiflora (Passion flower)		3-10			
	Clematis		3-10			
	Clematis vitalba (Travelers joy)		3-10			
	Grape vine (vitis vinifera)		3-30			
Scrambling Plants	Jasminum		2-8	  	<p>System 3 / 4 Width: min.300 - max.800 Heigth : min.300 - max2000</p> <p>System 5 Width: min.300 - max2000</p>	90-150
	Rose		2-4			
	Rubus		2-4			

I-NET GREENERY SYSTEMS

I-NET GREENERY SYSTEM WITH FRAME

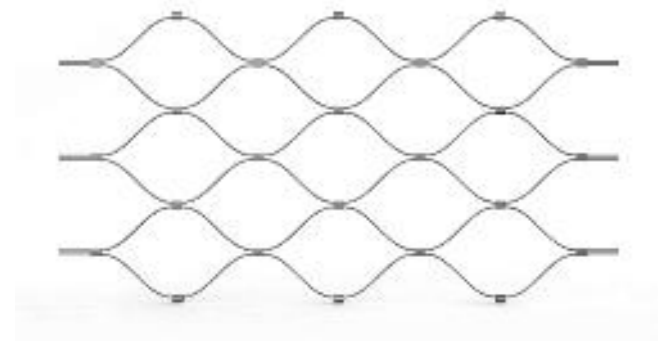

I-NET

Part Number	Rope	Dimensions in mm	
	Ø mm	NW	NH
IN-110-150-120	1,5	120	208
IN-110-150-180	1,5	180	312

Material AISI 316 L
 "NW" net width
 "NH" net height

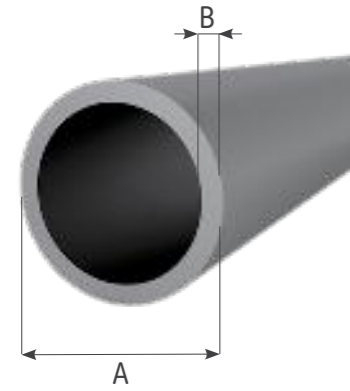

ROUND FRAME

Part Number	Dimensions in mm	
	A	B
IN-F-010-0021-020	21,3	2
IN-F-010-0026-020	26,9	2
IN-F-010-0033-026	33,7	2,6
IN-F-010-0042-026	42,4	2,6

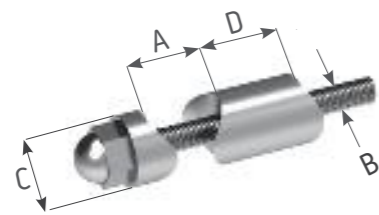

ROUND FRAME HOLDER

Part Number	Dimensions in mm			
	A	B	C	D
IN-F-015-021	21,3	M6	16	25
IN-F-015-026	26,9	M6	16	25
IN-F-015-033	33,7	M8	20	25
IN-F-015-042	42,4	M8	20	25

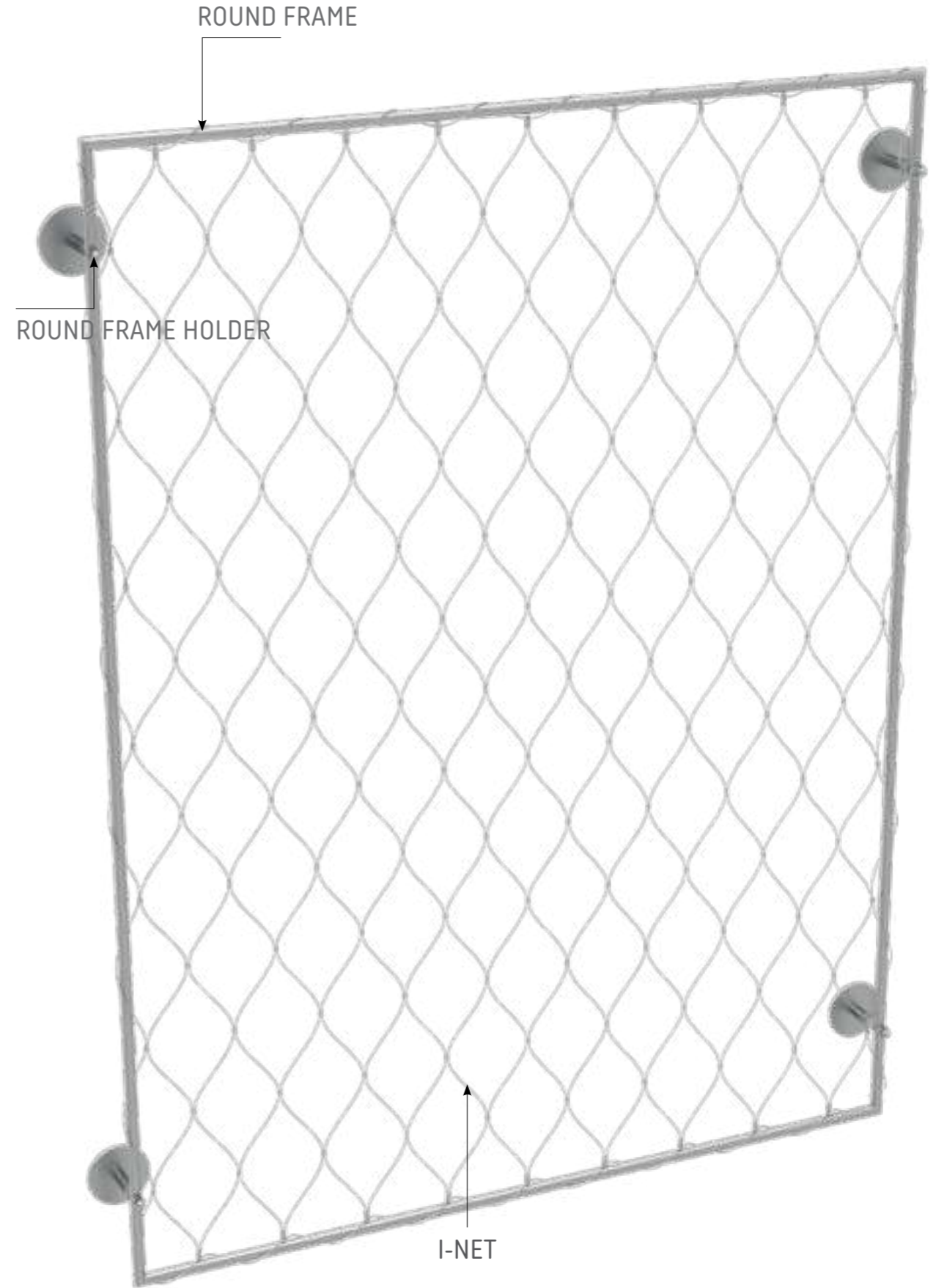

I-NET GREENERY SYSTEM WITH I-ROPE



I-NET

Part Number	Rope	Dimensions in mm	
	Ø mm	NW	NH
IN-110-150-120	1,5	120	208
IN-110-150-180	1,5	180	312

Material AISI 316 L
 "NW" net width
 "NH" net height

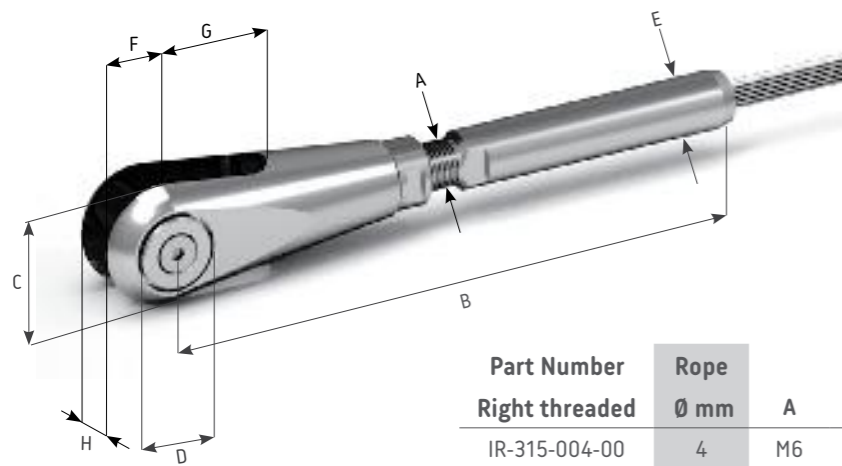

FORK WITH SWAGED FITTING

Part Number	Rope Ø mm	Dimensions in mm							
		A	B	C	D	E	F	G	H
IR-315-004-00	4	M6	89.2	15.5	6	7.5	8	11.5	6.6
IR-315-006-01	6	M8	107	20.6	8	12.5	11.2	14.8	8.8

Material AISI 316 / 1.4462 Duplex

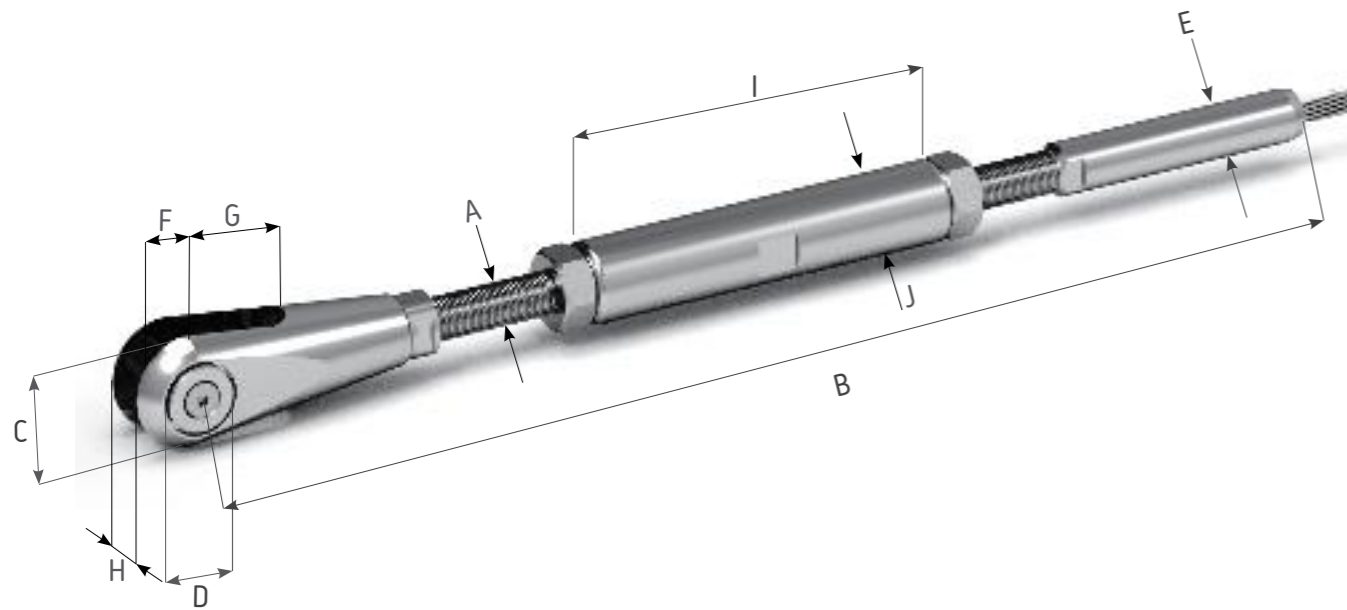

FORK WITH TURNBUCKLE AND SWAGED FITTING

Part Number	Rope Ø mm	Dimensions in mm											
		A	B	B _{max}	B _{min}	C	D	E	F	G	H	I	J
IR-325-004-00	4	M6	185	195	153	15.5	6	7.5	8	11.5	6.6	65	10
IR-325-006-01	6	M8	224	287	186	20.6	8	12.5	11.2	14.8	8.8	70	16

Material AISI 316 / 1.4462 Duplex

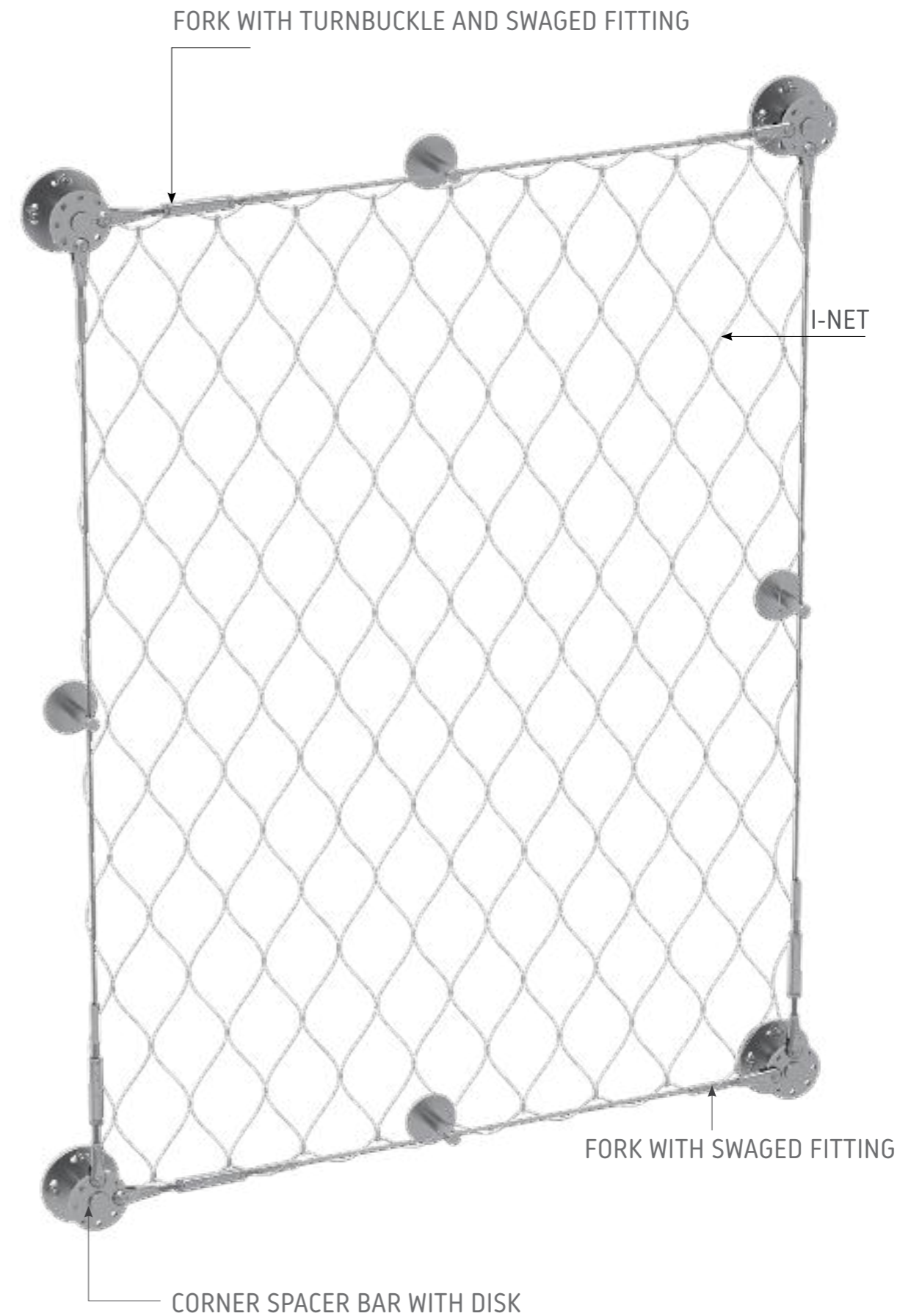

FORK WITH TURNBUCKLE AND SWAGED FITTING

I-NET

FORK WITH SWAGED FITTING

CORNER SPACER BAR WITH DISK

I-NET GREENERY SYSTEM WITH I-ROPE

CORNER CONNECTION DISK TYPES

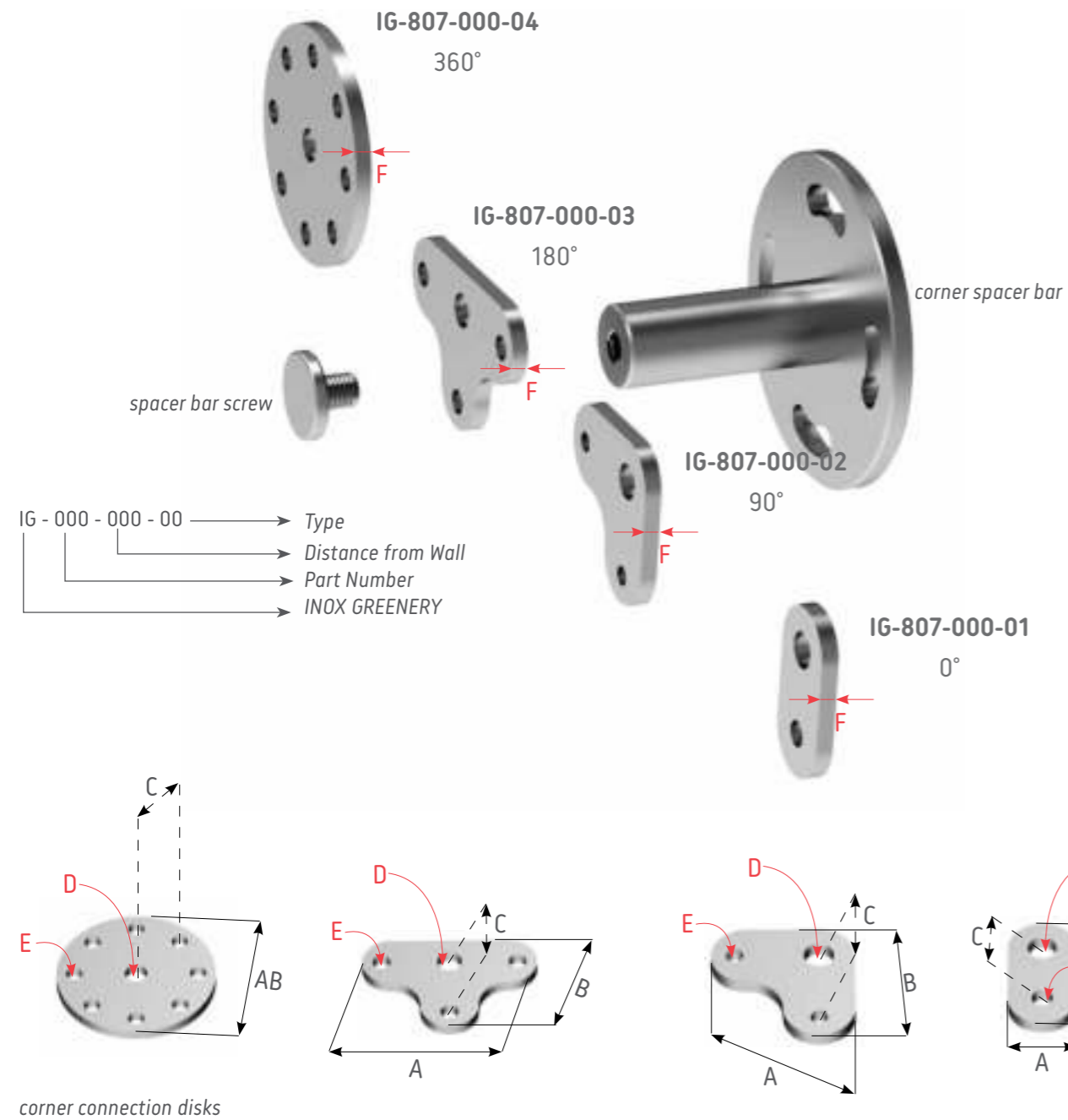

CORNER CONNECTION DISK

Part Number	Angle	Rope Ø mm	Dimensions in mm					
			A	B	C	D	E	F
IG-807-000-01	0°	*4 - 6	30	60	35	9	7	6
IG-807-000-02	90°	*4 - 6	60	60	35	9	7	6
IG-807-000-03	180°	*4 - 6	90	60	35	9	7	6
IG-807-000-04	360°	*4 - 6	90	90	35	9	7	6

Material AISI 316L

*For only Ø4mm and Ø6mm ropes

CORNER SPACER BAR WITH DISK

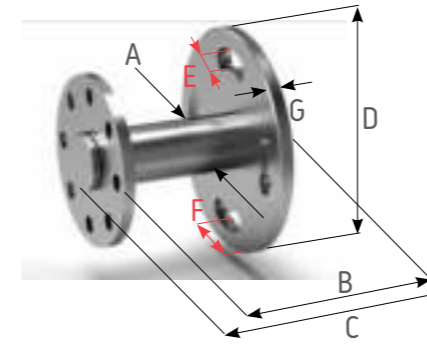

Part Number	Rope Ø mm	Distance from Wall	Dimensions in mm						
			A	B	C	D	E	F	G
IG-807-090-04	*4 - 6	90	30	90	98	120	M10	15	8
IG-807-120-04	*4 - 6	120	30	120	128	120	M10	15	8
IG-807-150-04	*4 - 6	150	30	150	158	120	M10	15	8

Material AISI 316L

*For only Ø4mm and Ø6mm ropes

CORNER SPACER BAR

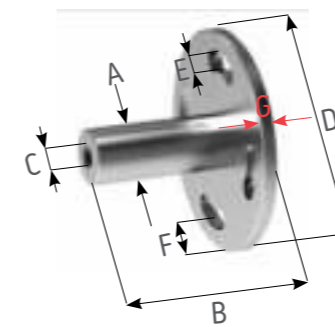

Part Number	Rope Ø mm	Distance from Wall	Dimensions in mm						
			A	B	C	D	E	F	G
IG-807-090-00	*4 - 6	90	30	87	M8	120	M10	15	8
IG-807-120-00	*4 - 6	120	30	117	M8	120	M10	15	8
IG-807-150-00	*4 - 6	150	30	147	M8	120	M10	15	8

Material AISI 316L

*For only Ø4mm and Ø6mm ropes

SPACER BAR SCREW

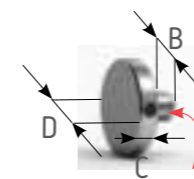

Part Number	Dimensions in mm			
	A	B	C	D
IG-804-020-01	M8	16	5	20
IG-804-025-01	M8	16	5	25
IG-804-030-01	M8	16	5	30
IG-804-030-02	M10	10	5	30
IG-804-020-02	M12	15	5	20
IG-804-025-02	M12	15	5	25
IG-804-030-03	M16	15	5	30

Material AISI 316L



SPACER BAR

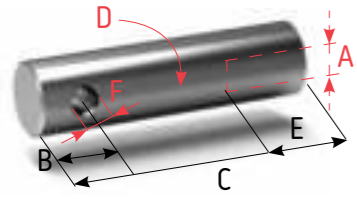

Part Number	Rope	Distance from Wall	Dimensions in mm					
	Ø mm		A	B	C	D	E	F
IG-817-090-00	*4 - 6	90	M8	15	97	20	20	8.5
IG-817-120-00	*4 - 6	120	M10	15	127	25	30	8.5
IG-817-150-00	*4 - 6	150	M10	15	152	25	30	8.5

Material AISI 316L

SPACER BAR WITH THREAD

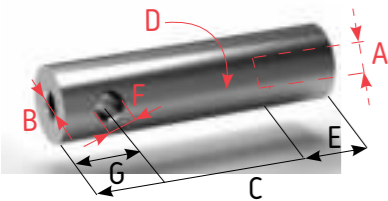

Part Number	Rope	Distance from Wall	Dimensions in mm						
	Ø mm		A	B	C	D	E	F	G
IG-801-090-00	*4 - 6	90	M8	M8	97	20	20	8.5	15
IG-801-120-00	*4 - 6	120	M10	M8	127	25	30	8.5	15
IG-801-150-00	*4 - 6	150	M10	M8	152	25	30	8.5	15

Material AISI 316L

*For only Ø4mm and Ø6mm ropes

CROSS SPACER BAR

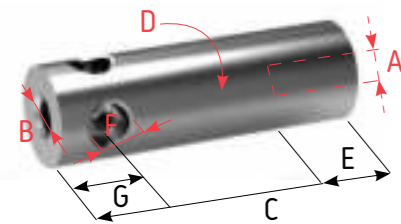

Part Number	Rope	Distance from Wall	Dimensions in mm						
	Ø mm		A	B	C	D	E	F	G
IG-802-090-00	*4 - 6	90	M12	M10	97	30	30	12	10
IG-802-120-00	*4 - 6	120	M12	M10	127	30	30	12	10
IG-802-150-00	*4 - 6	150	M12	M10	152	30	30	12	10

Material AISI 316L

*For only Ø4mm and Ø6mm ropes

CROSS CLAMP SPACER BAR

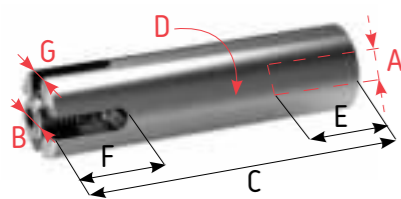

Part Number	Rope	Distance from Wall	Dimensions in mm						
	Ø mm		A	B	C	D	E	F	G
IG-803-090-01	*4 - 6	90	M8	M12	97	20	20	22	6.5
IG-803-120-01	*4 - 6	120	M10	M12	127	25	30	22	6.5
IG-803-150-01	*4 - 6	150	M10	M12	152	25	30	22	6.5
IG-803-120-02	*4 - 6	120	M12	M16	127	30	30	30	8.5
IG-803-150-02	*4 - 6	150	M12	M16	152	30	30	30	8.5

Material AISI 316L

*For only Ø4mm and Ø6mm ropes

COVER DISK WITH INTERNAL THREAD

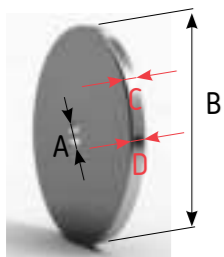

Part Number	Thread	Dimensions in mm		
	A	B	C	D
IG-805-080-01	M8	80	5	3.5
IG-805-080-02	M10	80	5	3.5
IG-805-080-03	M12	80	5	3.5

Material AISI 316L

*For only Ø4mm and Ø6mm ropes



GREENERY ACCESSORIES

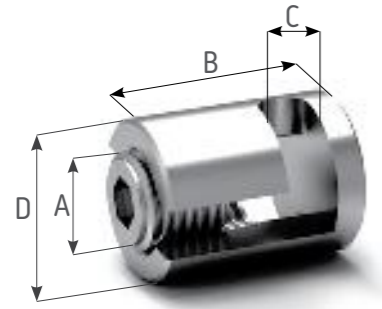

CROSS CLAMP ADJUSTABLE

Part Number	Rope Ø mm	Dimensions in mm			
		A	B	C	D
IG-808-004-00	4	M12	22	4,5	20
IG-808-006-00	6	M12	26	6,5	20
IG-808-008-00	8	M12	32	8,5	20

Material AISI 316 L

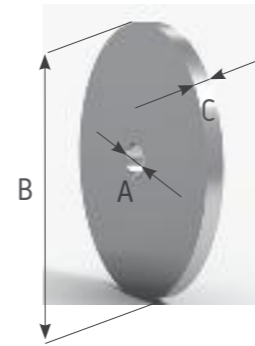

COVER DISK

Part Number	Dimensions in mm		
	A	B	C
IG-806-080-01	10,5	80	5
IG-806-080-02	12,5	80	5

Material AISI 316 L

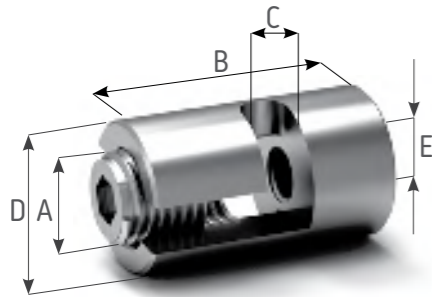

CROSS CLAMP WITH INTERNAL THREAD ADJUSTABLE

Part Number	Rope Ø mm	Dimensions in mm				
		A	B	C	D	E
IG-809-004-00	4	M12	30	4,5	20	M8
IG-809-006-00	6	M12	34	6,5	20	M8
IG-809-008-00	8	M12	40	8,5	20	M8

Material AISI 316 L

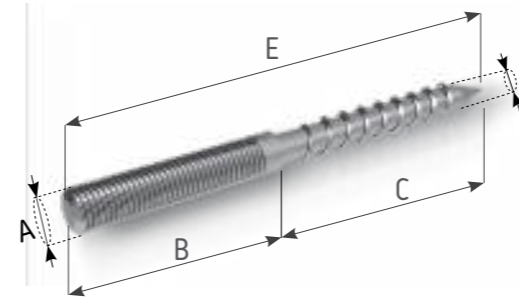

DUAL THREAD SCREW

Part Number Right threaded	Part Number Left threaded	Thread A	Dimensions in mm			
			B	C	D	E
917-008-00	918-008-00	M8	40	60	6,9	100
917-010-00	-	M10	30	40	8,9	70

Material AISI 316

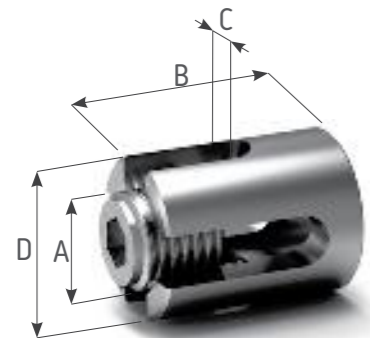

CROSS CLAMP 90°

Part Number	Rope Ø mm	Dimensions in mm			
		A	B	C	D
IG-810-004-00	4	M12	22	4,5	20
IG-810-006-00	6	M12	26	6,5	20
IG-810-008-00	8	M16	27	8,5	30

Material AISI 316 L

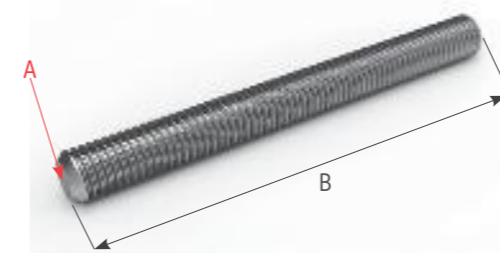

THREADED ROD

Part Number Right threaded	Part Number Left threaded	Thread A	Dimensions in mm	
			B	
919-008-01	920-008-01	M8	100	
919-008-10	920-008-10	M8	200	
919-010-01	920-010-01	M10	100	
919-010-10	920-010-10	M10	200	
919-012-01	920-012-01	M12	100	
919-012-10	920-012-10	M12	200	

Material AISI 316

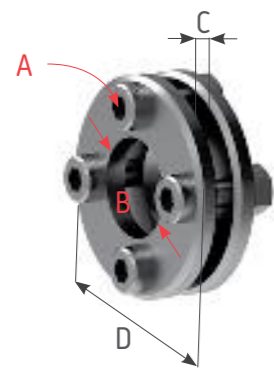

CROSS CLAMP 0-180°

Part Number	Rope Ø mm	Dimensions in mm			
		A	B	C	D
IG-811-040-00	*4 - 6	M5	18	4	40

Material AISI 316 L

*For only Ø4mm and Ø6mm ropes

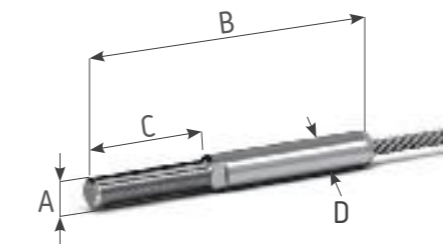

EXTERNAL THREAD ROLL SWAGED FITTING

Part Number Right threaded	Part Number Left threaded	Set Number	Rope Ø mm	Dimensions in mm			
				A	B	C	D
IR-150-004-00	IR-150-004-01	IRS-120-004-00	4	M6	75	35	7,5
IR-150-006-00	IR-150-006-01	IRS-120-006-00	6	M10	109	45	12,5
IR-150-008-00	IR-150-008-01	IRS-120-008-00	8	M12	144	60	16

Material AISI 316 L

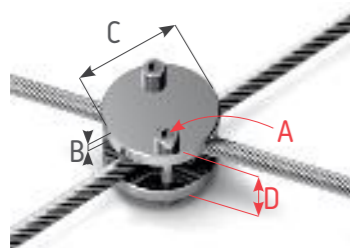

CROSS CLAMP

Part Number	Rope Ø mm	Dimensions in mm			
		A	B	C	D
IR-530-004-06	4-6	M4	5	35	18/22
IR-530-008-12	8-12	M6	8	45	32/40

Material AISI 316

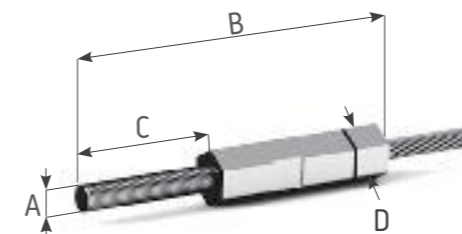

EXTERNAL THREAD SWAGELESS CONNECTION

Part Number Right threaded	Part Number Left threaded	Set Number	Rope Ø mm	Dimensions in mm			
				A	B	C	D
IR-170-004-00	IR-170-004-01	IRS-140-004-00	4	M6	110	60	13
IR-170-006-00	IR-170-006-01	IRS-140-006-00	6	M8	115	60	15
IR-170-008-00	IR-170-008-01	IRS-140-008-00	8	M10	160	80	19

Material AISI 316 L

GREENERY SYSTEM INSTALLATION EXAMPLES

System 1
I-NET Frame System

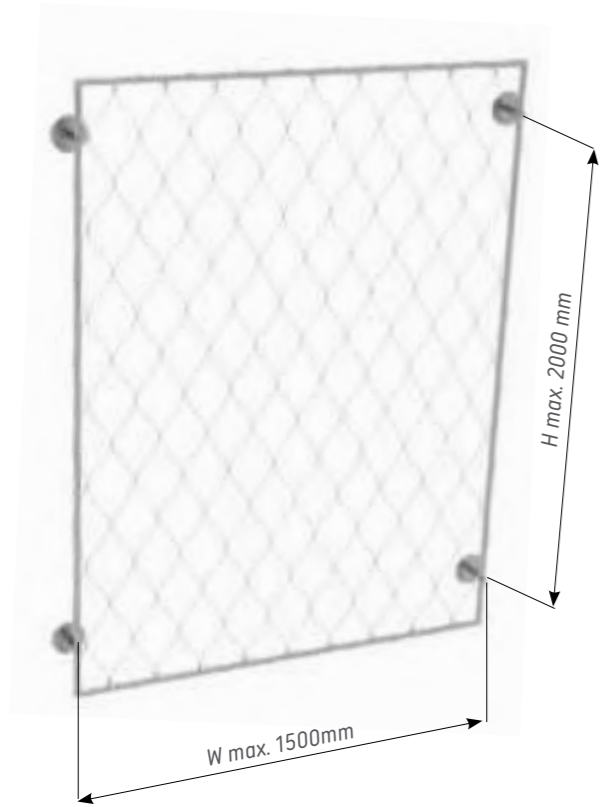

System 2
I-NET Frame System with I-ROPE

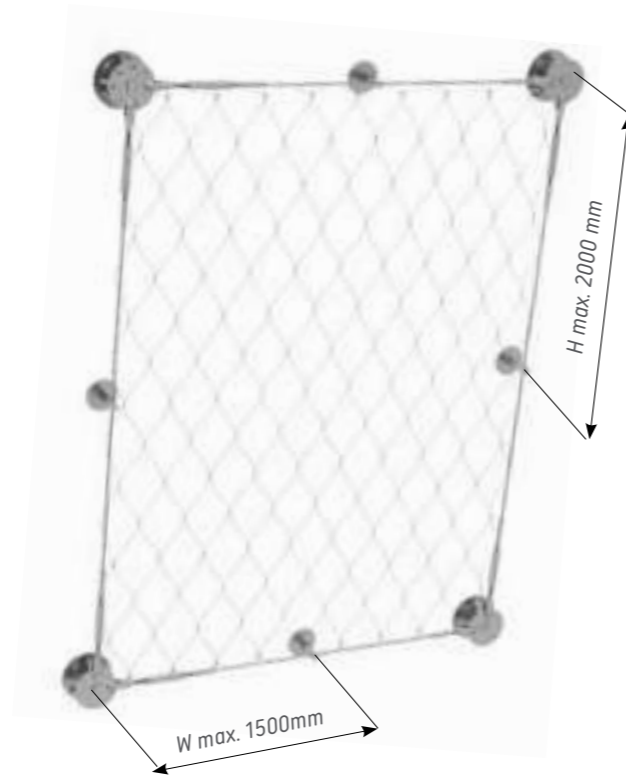

System 5
I-ROPE Horizontal System

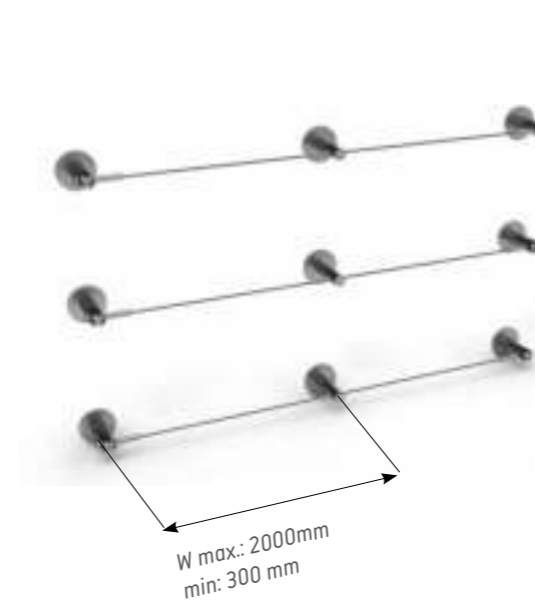

System 6
I-ROPE Vertical System

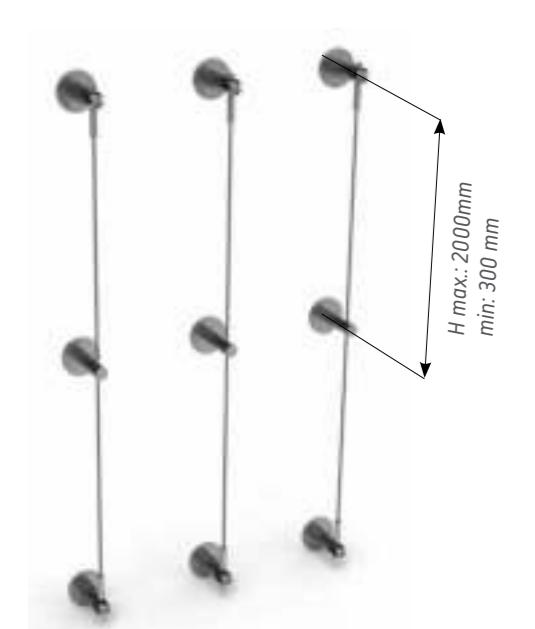

System 3
I-ROPE Grid System 1

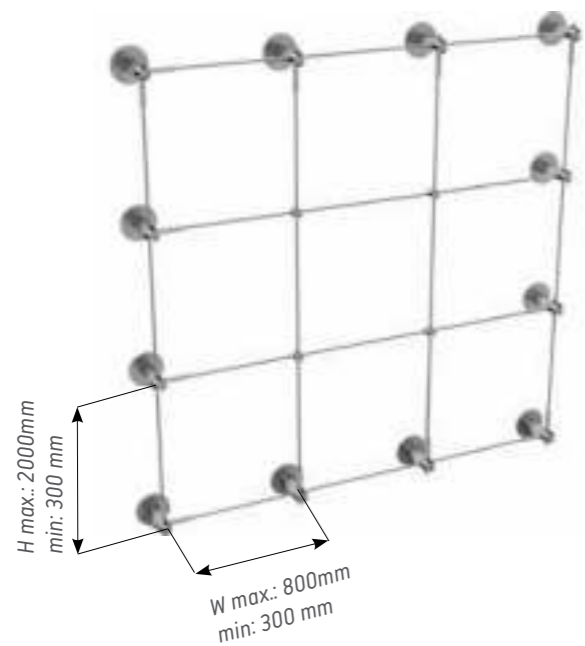

System 4
I-ROPE Grid System 2

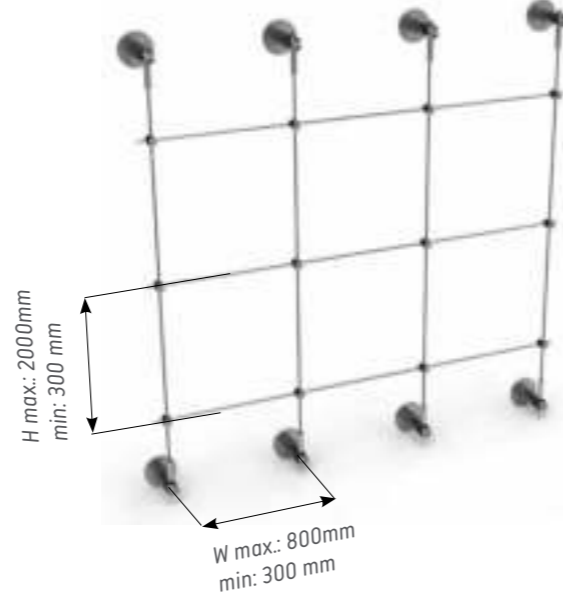

System 7
I-ROPE Diagonal System 1

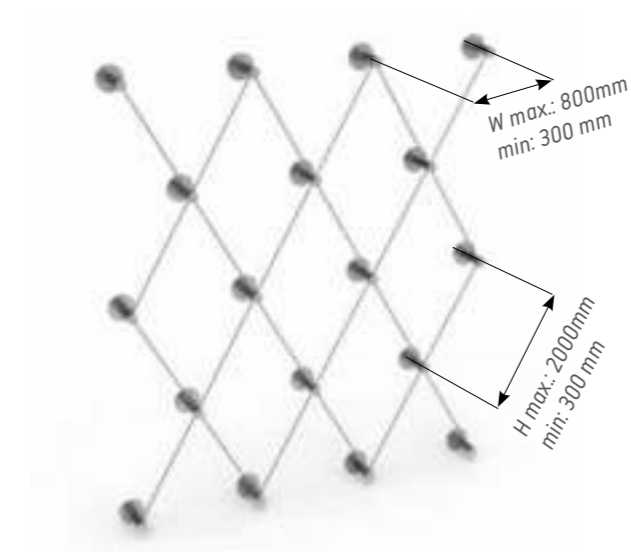

System 8
I-ROPE Diagonal System 2

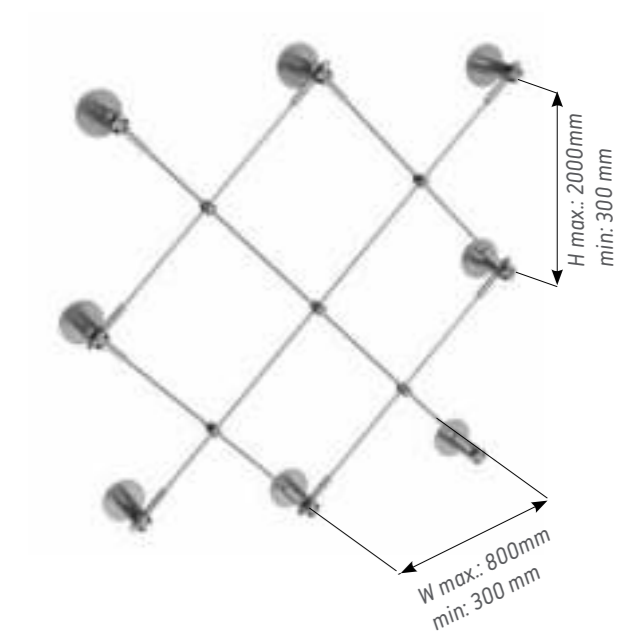

CHARACTERISTICS OF WIRE ROPES

Explanation and Application of Wire Ropes

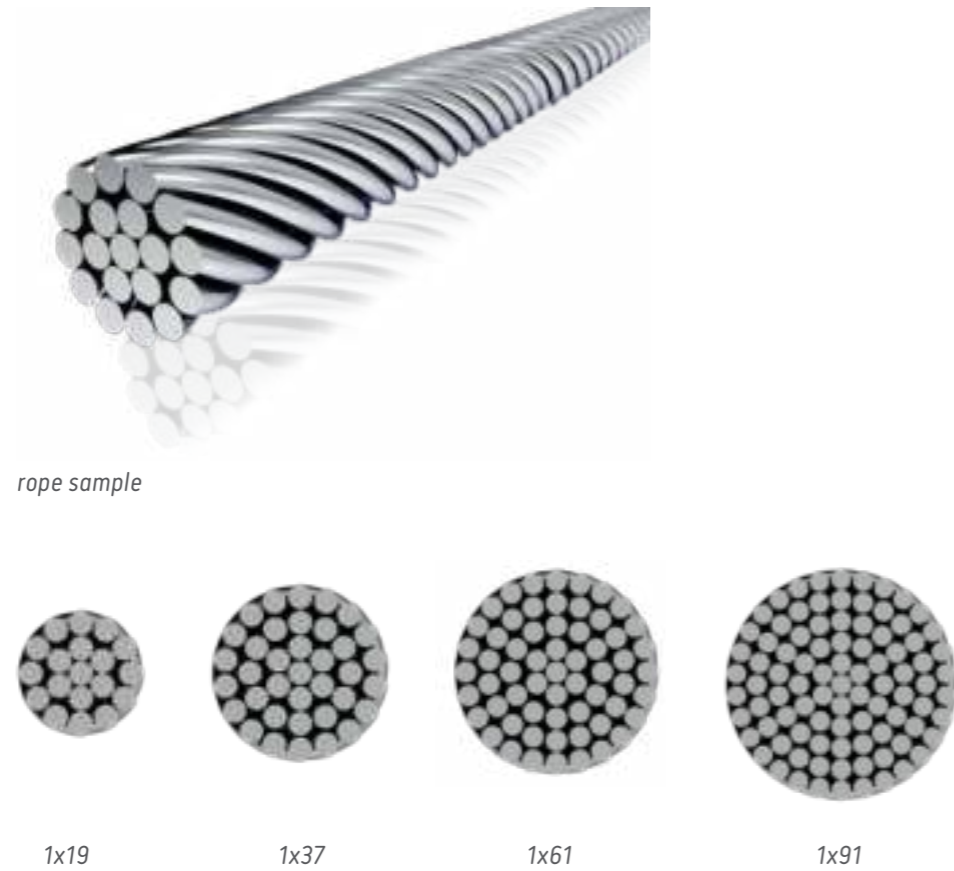

Type of Wire Rope	Explanation
Spiral Ropes	<p>Consist of several layers of individual round wires. They are manufactured from stainless steel wire. If an open spiral rope forms part of a strand rope, it is called "strand". The designation of the various types of wire rope constructions depends on the number of wires in the rope cross section.</p>
Type of Wire Rope	Applications
Spiral Ropes	<p>Carrier cables for lightweight membran structures, Carrier/tensioning cables in cable nets, Carrier cables for light suspension bridges, Hanger cables for suspension bridges, Balustrade cables for suspension bridges, Bottom flange cables for load-bearing structures.</p>

CHARACTERISTICS OF WIRE ROPES

Explanation and Application of Wire Ropes

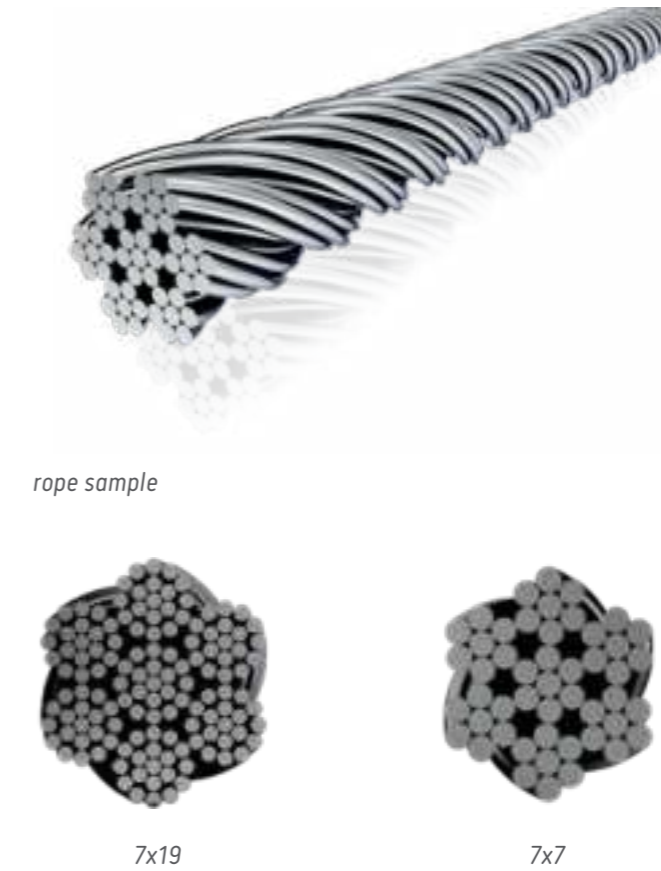

Type of Wire Rope	Explanation
Strand Ropes	<p>Wire ropes consist of a number of strands twisted together. This construction makes them very flexible. The code for this type of wire depends on the number of strands and the number of wires per strand.</p>
Type of Wire Rope	Applications
Strand Ropes	<p>Tensioning cables for lightweight membran structures, Hanger cables for suspension bridges, Balustrade cables for bridges, Bottom flange cables for load-bearing structures, Cross-bracing structures.</p>

Technical Information About Wire Ropes

SPIRAL / STRAND ROPE "DIN EN 12385-10"

Material : Stainless steel wire 1.4401 (AISI 316) to DIN EN 10264-4

Modulus of Elasticity : 130 kN/mm² ± 10 kN/mm²

Tolerance on Diameter : 0% / +3%

Socketing : D= 4-40mm Swaging

Rope Ø mm	Minimum Breaking Force F _{min} [kN]	Charact. Breaking Force F _{uk} (1) [kN]	Tension Strength FRd (2) [kN]	Metallic Cross Section A [mm ²]	Stiffness EA [MN]	Weight [kg/m]
4	13	11.8	7.2	10	1.28	0.1
6	27	24.3	14.7	22	2.86	0.2
8	49	44.1	26.7	39	5.07	0.3
10	76	68.4	41.5	60.7	7.9	0.5
12	110	99	60	88	11.4	0.7
14	149	134.1	81.3	120	15.5	1
16	206	185.4	112.4	154	20.1	1.3
18	261	234.9	142.4	197	25.6	1.6
20	322	289.8	175.6	244	31.7	2
22	389	350.1	212.2	293	38.1	2.4
24	463	416.7	252.5	350	45.5	2.9
26	544	489.6	296.7	410	53.3	3.4
28	629	566.1	343.1	474	61.6	3.9
30	724	651.6	394.9	545	70.8	4.5
32	824	741.6	449.5	618	80.4	5.1
34	929	836.1	506.7	701	91.1	5.8
36	1042	937.8	568.4	784	102	6.5
38	1086	977.4	592.4	838	109	6.9
40	1198	1078.2	653.5	929	121	7.7

F_{min}: Minimum Breaking Force.

F_{uk}: Breaking Strength of Wire Ropes Inc. End Connectors.

FRd: Limit Tension Resistance of the Wire Ropes Inc. End Connectors.

ke: Loss Factor.

$F_{uk} = F_{min} \times k_e$.

$FRd = (F_{min} \times k_e) / 1,65$.

$k_e = 0,9$ (swaged fitting)



OVERVIEW OF STAINLESS STEEL

Material

Stainless steel is an iron-based alloy which contains 10,5% chromium. This element keeps it self stain proof by creating a chromium-oxide layer on the surface of the material.

316 is a type of austenitic stainless steel which is a popular grade as 304 with a higher corrosion resistance.

Different to 304 it contains Molybdenum and higher Nickel as well as Chromium contents. Since INOX-NET products are used widely in outer weather conditions. INOX-NET prefers 316 grade because of its better resistance to chemicals and chlorides (like salt). 316L has a better corrosion resistance and welding behaviour containing less Carbon. 316Ti has a better corrosion resistance compared to 316L with its Titanium content and higher friction resistance.

On the other hand Duplex stainless steel has both better corrosion and mechanical properties than 316L and 316Ti. Thus INOX-NET prefers duplex stainless steel for the individual properties requested by special projects.

MATERIAL GROUPS

	EN 10088-3		AISI	Cmax.	Cr	Ni	Div	Type
AISI 316 group	1.4401	X5CrNiMo17-12-2	316	0.07	18	10		Austenitic
	1.4404	X2CrNiMo17-12-2	316L	0.03	17	11	Mo	Austenitic
	1.4408	GXCrNiMo19-11-2		0.07	19	10		Austenitic
	1.4435	X2CrNiMo18-14-3	316L	0.03	18	12		Austenitic
	1.4571	X6CrNiMoTi17-12-2	316Ti	0.1	18	10	Ti	Austenitic
Duplex group	1.4462	X2CrNiMoN22-5-3	2205	0.03	21-23	4,5-6,5	Mo	Austenitic-Ferritic
	1.4410	X2CrNiMoN25-7-4	2507	0.03	24-26	6-8	Mo	Austenitic-Ferritic
Designation	European		USA	Carbon	Chromium	Nickel	Ti = Titanium	
	Standard		Standard				Mo = Molybdenum	

CRITERIA OF DIFFERENTIATION AISI 316 / DUPLEX

	AISI 316		Duplex
Material Number	1.4401	1.4404	1.4462
	1.4408	1.4435	1.4410
	1.4436	1.4571	
Properties	weather-proof		weather-proof
	highly acid-resistant	highly acid and corrosion resistant highly resistant to aqueous environment and seawater higher mechanical properties	



Corrosion

Although stainless steel is resistant to corrosion by its self passivation mechanism rust may occur in some situations.

Some reasons of rust;

- Contamination by iron particles in the atmosphere or by iron dust from the nearby operations such as grinding, drilling and cutting.
- Lack of cleaning.
- Defects in design selecting the correct grade, finishing .
- Combination with other materials only stainless steel fasteners should be used on stainless steel components.

How To Avoid Corrosion?

- Correct and appropriate grade should be selected for the environment during the design phase (AISI 304, AISI 314 are not resistant to the sea water and chloridic water, AISI 316 has a limited resistance to seawater, Duplex is resistant to seawater).
- Stainless steel should be cleaned often enough to maintain a good appearance and preserve corrosion resistance.
- Keep away from hydrochloric acid, chloride or fluoride.

Maintenance and Cleaning

- Rinse with water to remove dirt. High pressure jet cleaners can be used.
- Wash with warm water containing soap or %5 ammonia using a soft brush.
- To remove rust use domestic cleaning creams or polishes which may contain calcium carbonate or citric acid.
- Soft cleaning cloths.

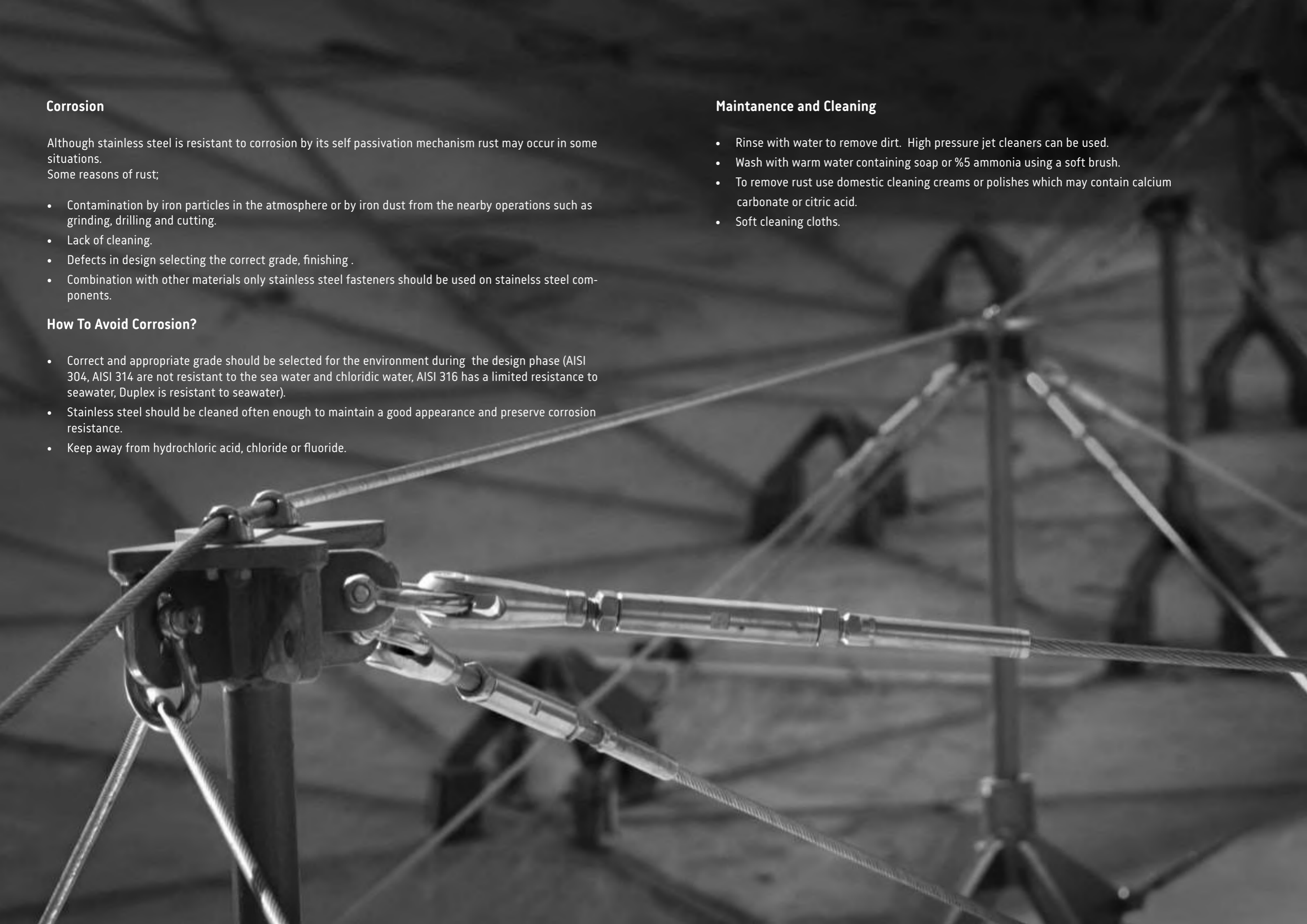

TECHNICAL TIPS

ROPE FORCES AND TENSIONING

To make up an effective total, rope force and preload force should be applied as a combination. The ropes are held by means of fittings such as end stops and nuts. The length of the rope can be adjusted by the help of this joints.

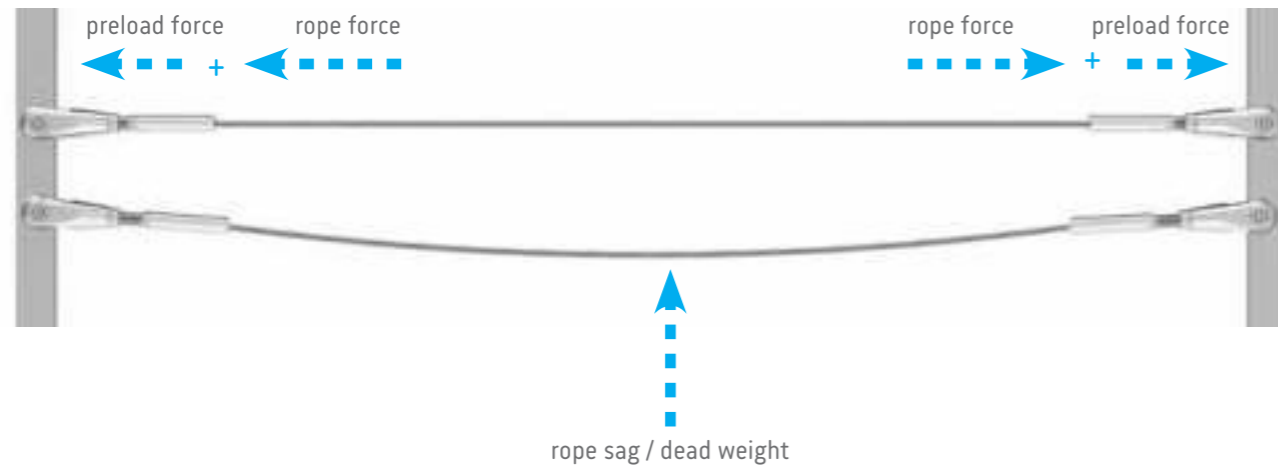

Tightening and Loosening Descripton of Rope System

Right Hand / Left Hand Thread

Where it is not possible to tension the rope from outside then a rope configuration with right hand /left hand thread should be used. The tensioning and releasing is effected by turning the entire rope. Both side right or both side left hand thread is used where the rope can be tensioned from outside.

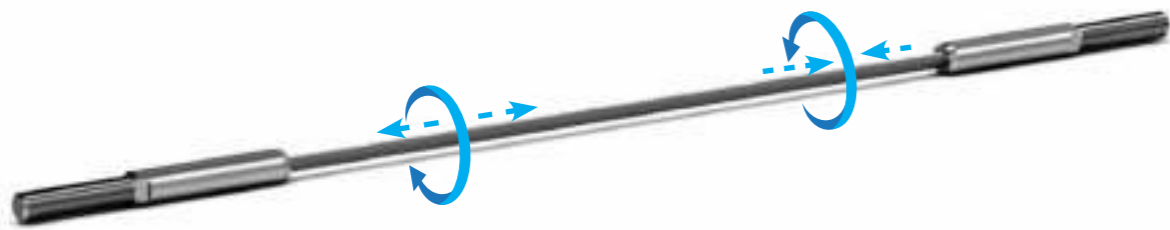

ASSEMBLY LENGTHS

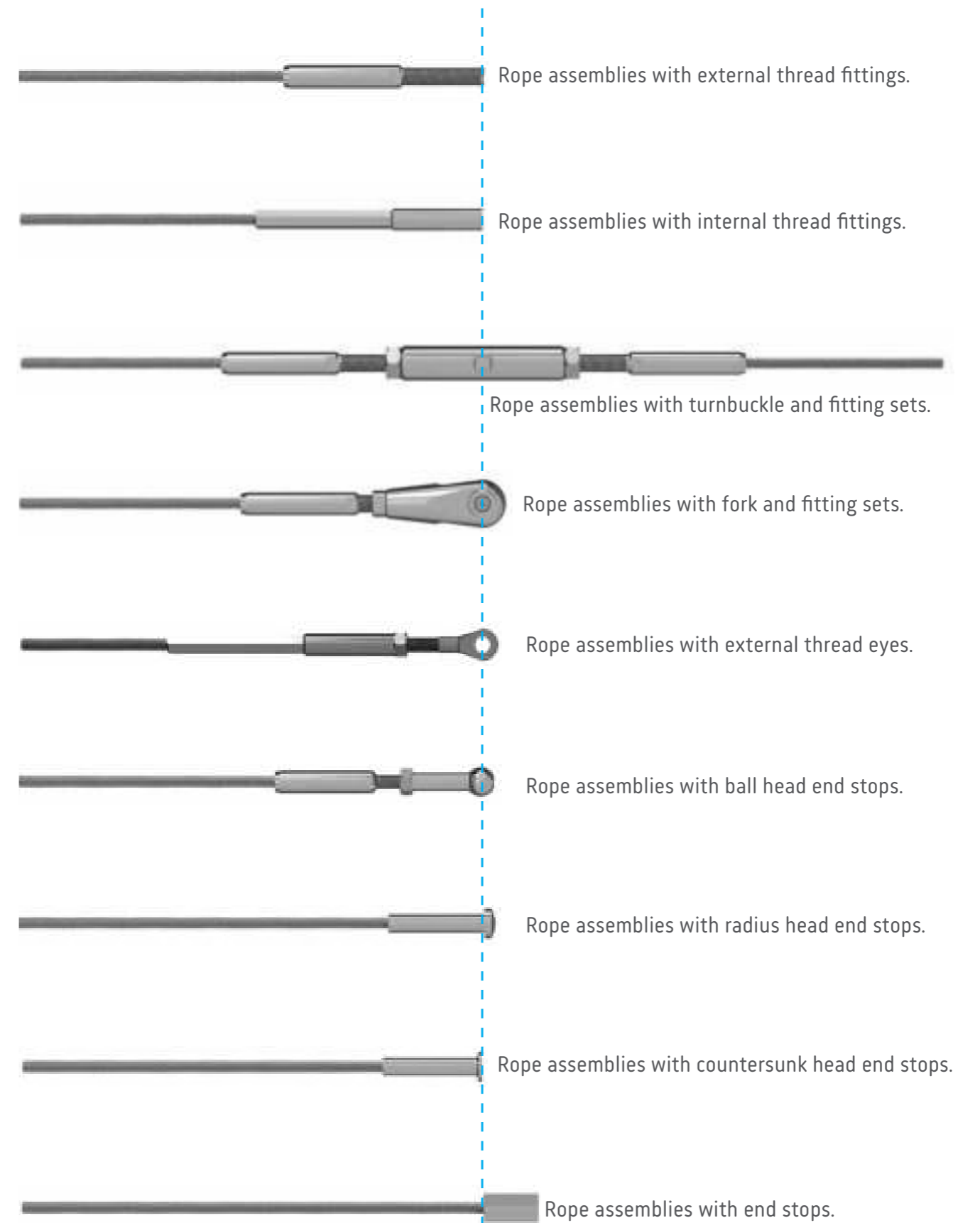

**reference line for production dimension*



OUR GOALS

As INOX-NET we have recently begun establishing new services in Turkey, however our factory and office goals are:

- Our goals as a company is to introduce our products within Turkey and the world. To provide our best services putting our product quality in the forefront while always ensuring customer satisfaction.
- Being the preferred company due to its professional management, which delivers absolute quality both at home and abroad,
- Being the first choice company by creating a working environment where employees are happily working as a member of the INOX-NET family.
- To demonstrate our quality all over the world, to increase our reputation and to expand our core competencies and competitiveness while competing,
- To continuously improve our research and development activities for a portfolio containing economic, high-quality and innovative products.



 **vomet**
PRIEMYSELNÉ SÍTÁ