

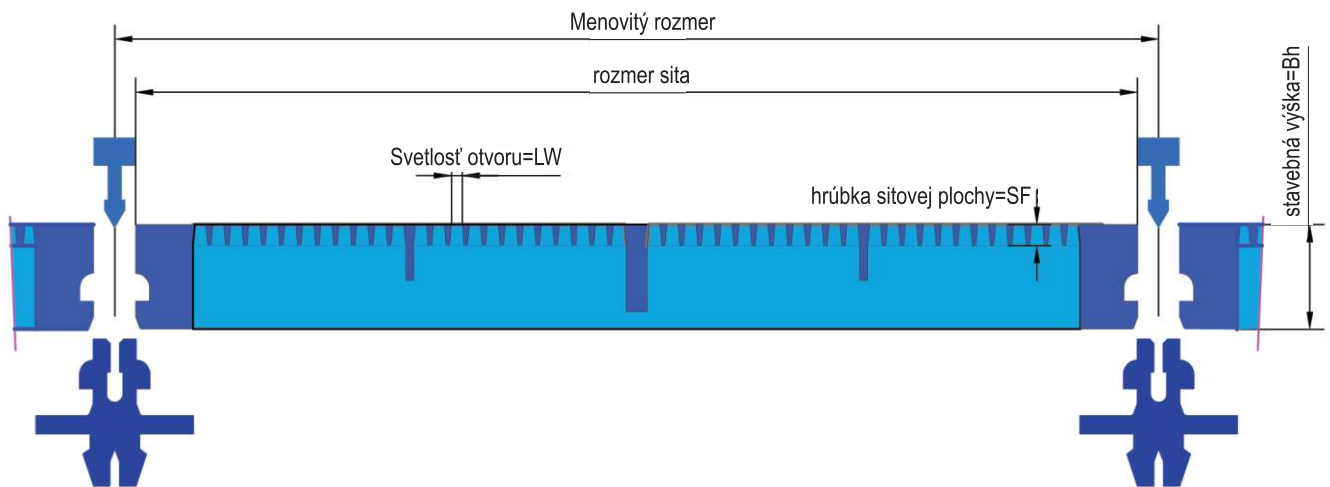

Definícia rozmerov



Menovitý rozmer=Štandard 300 mm, možný 80-400 mm

Shore - tvrdosti: 55°, 65°, 75°, 85°, 90° Shore A

Sitový modul

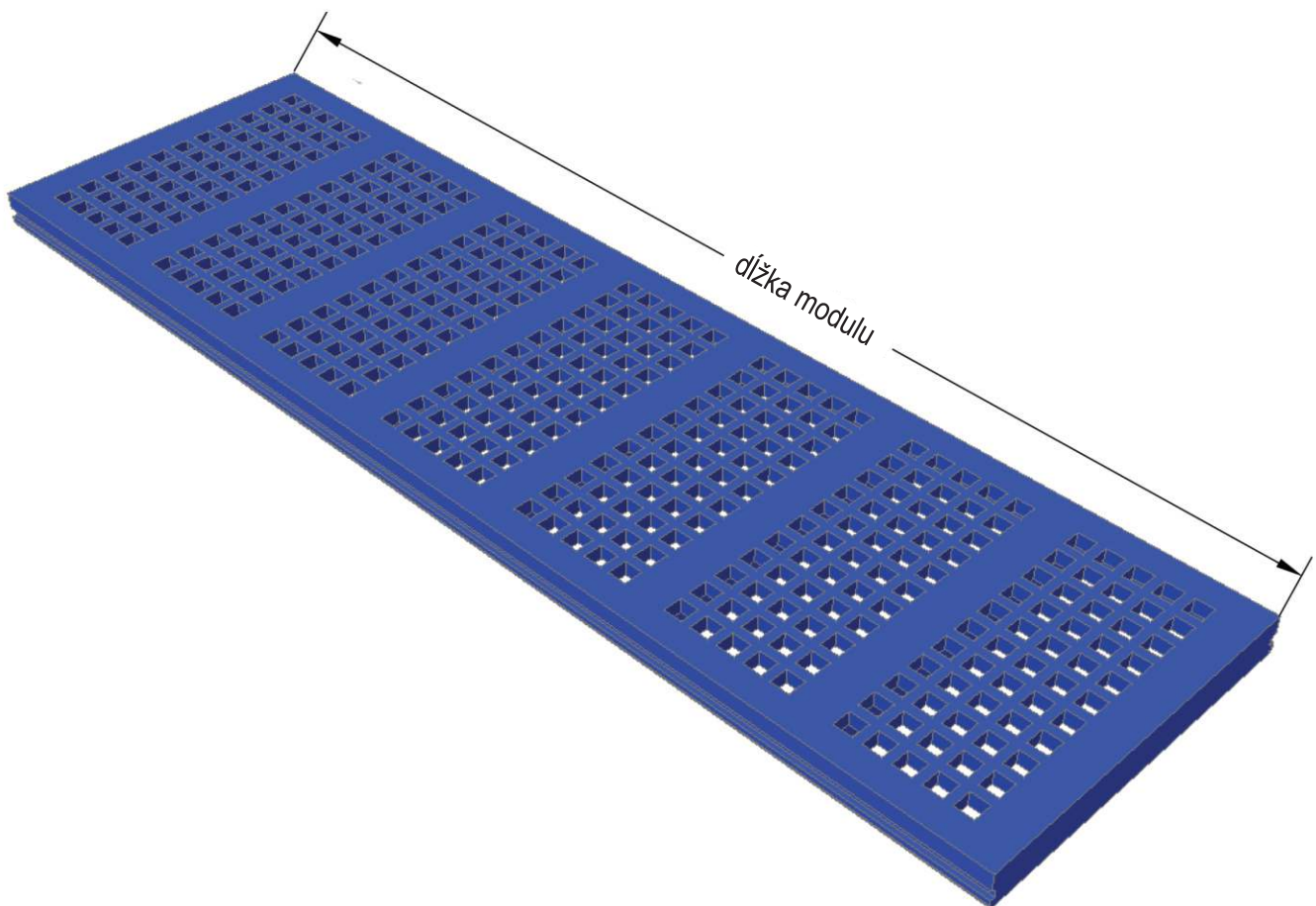

Dĺžka modulu: Štandard 1000 mm. Dĺžky až do 1600 mm možné





Štvorhranné oká

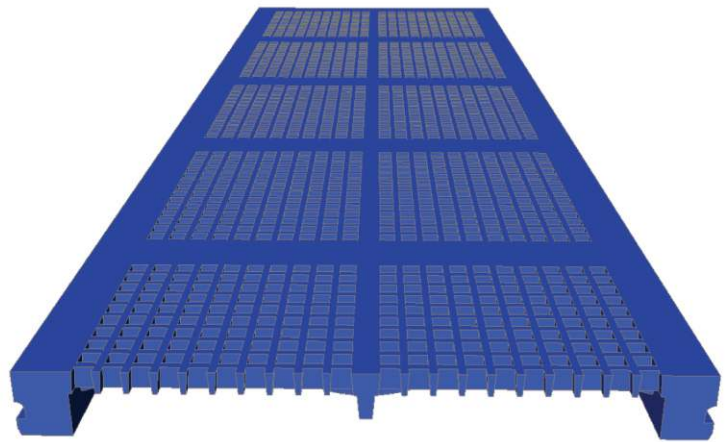
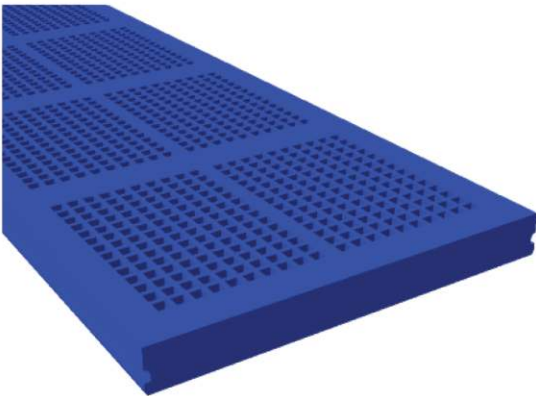
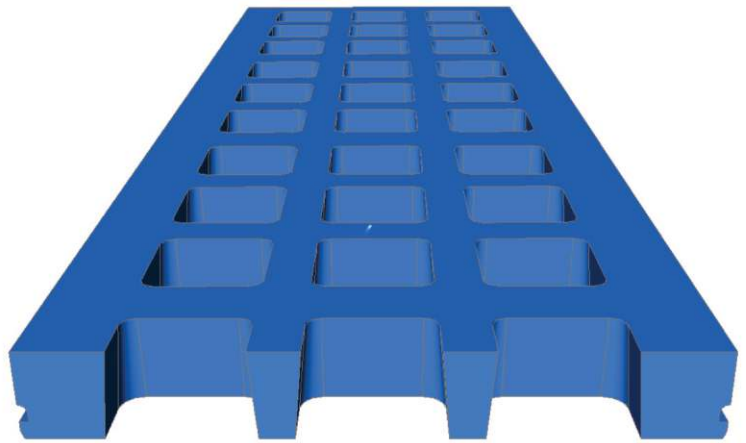
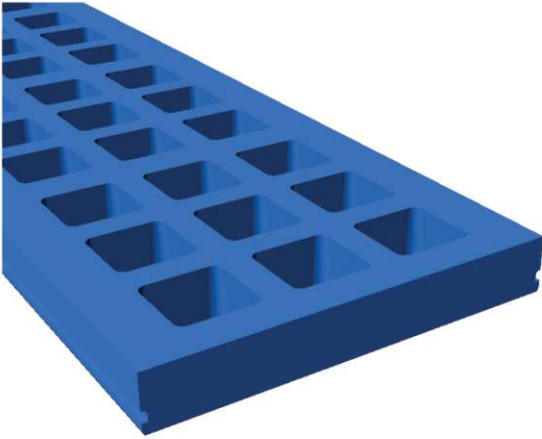

Obdĺžnikové oká

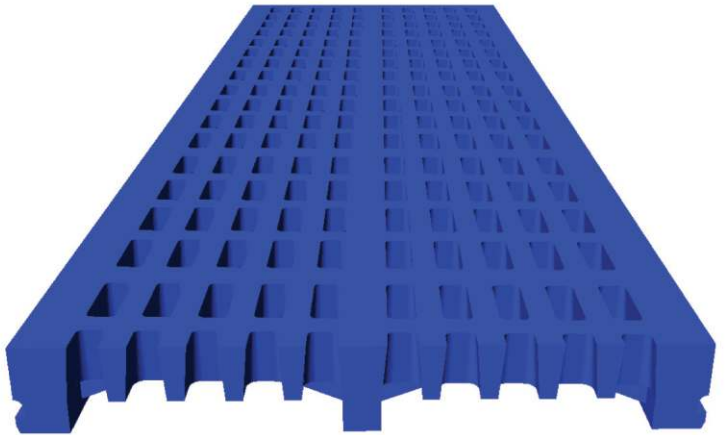
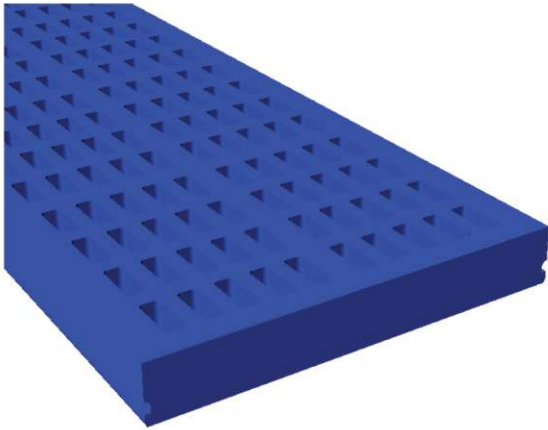

Odvodňovacie moduly s termoplastickými poľami

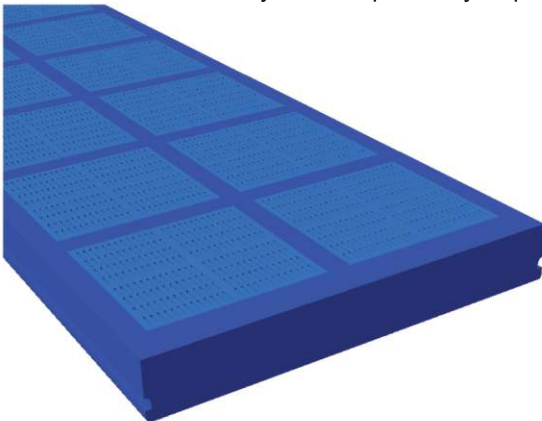

ClipTec® Program

Výmenný sitový systém



Vomet, spol. s r. o.
Trstínska cesta 19, 917 01 Trnava
Slovenská republika
www.vomet.sk



seit 1879

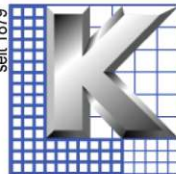

Soffflex

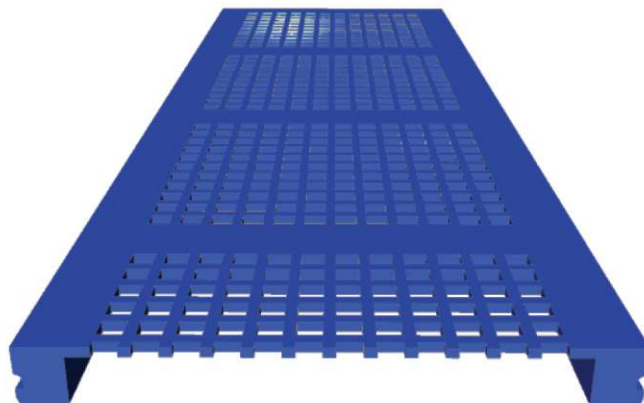
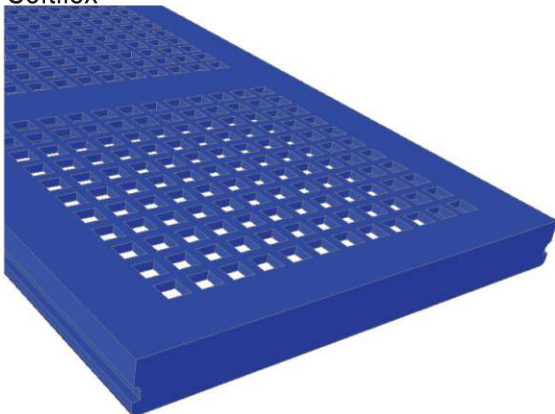

ClipClean® Soffflex

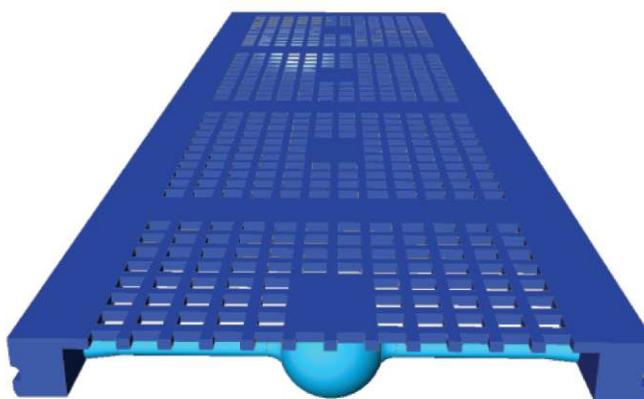
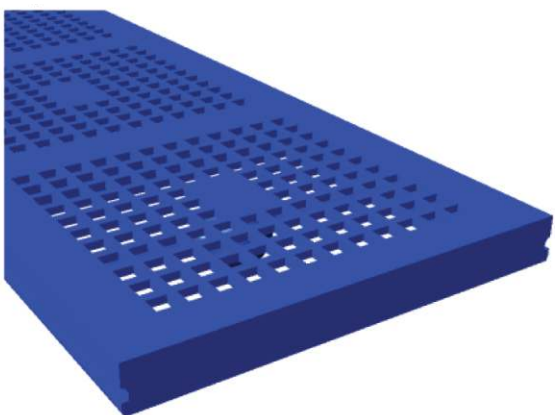

Membran

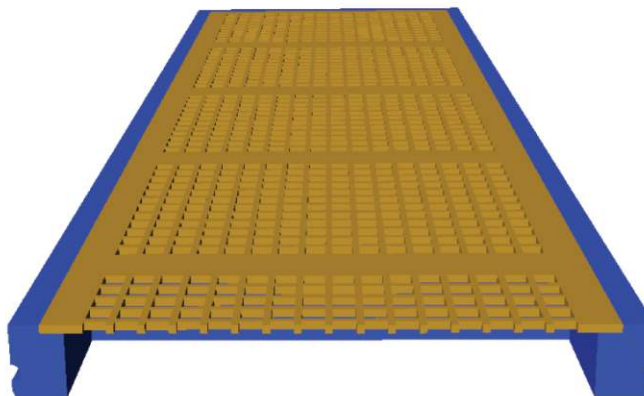
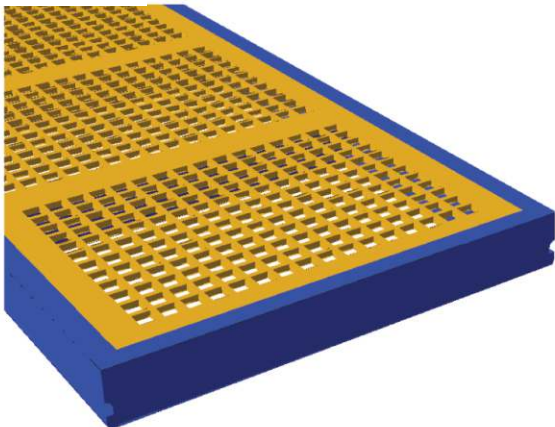

ClipClean® Membran

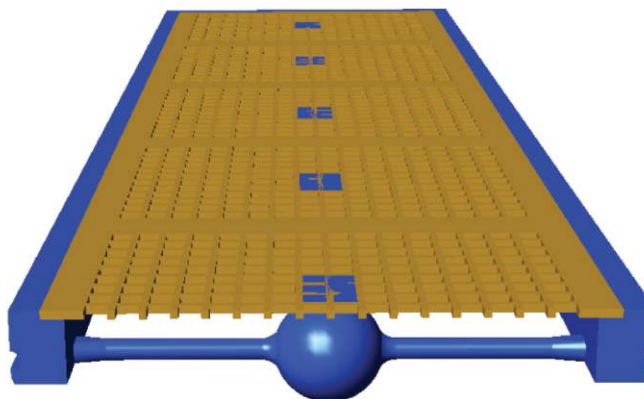
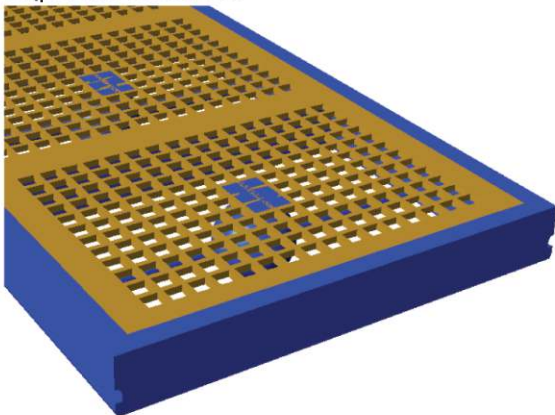

ClipTec® Program

Výmenný sitový systém



Vomet, spol. s r. o.
Trstínska cesta 19, 917 01 Trnava
Slovenská republika
www.vomet.sk



seit 1879



Oceľové prstové sitá

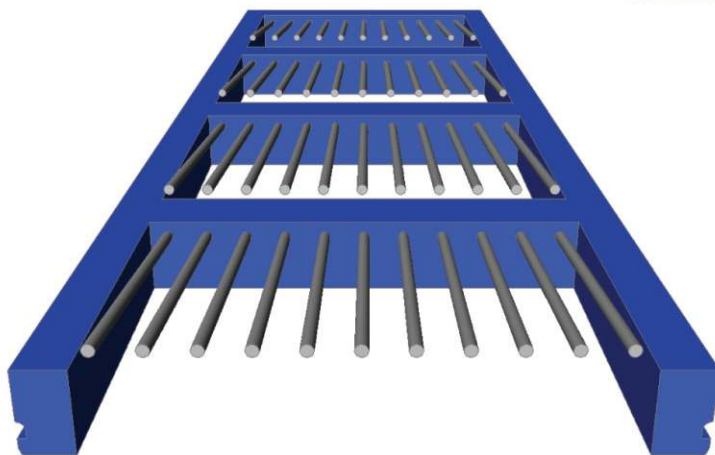
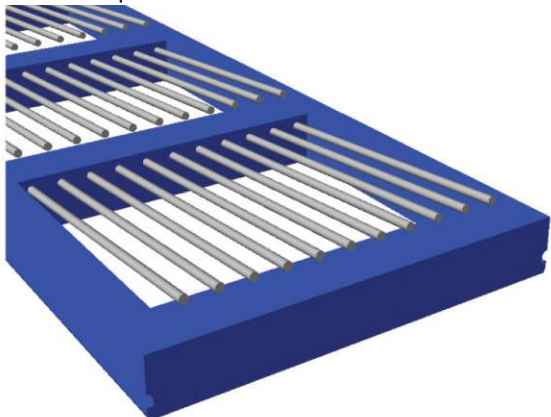

PU prstové sitá

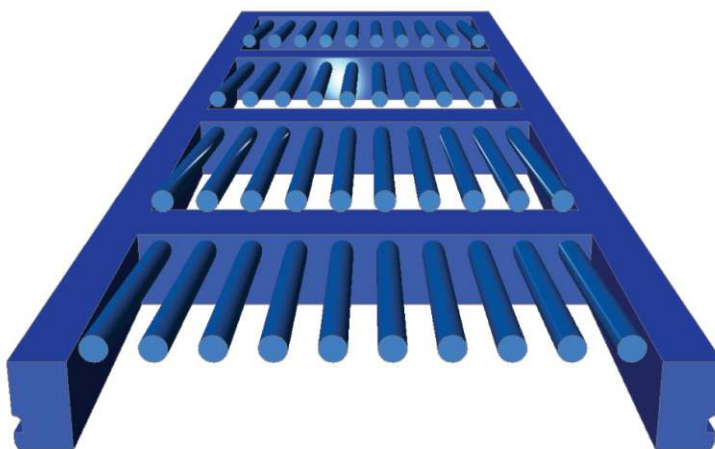
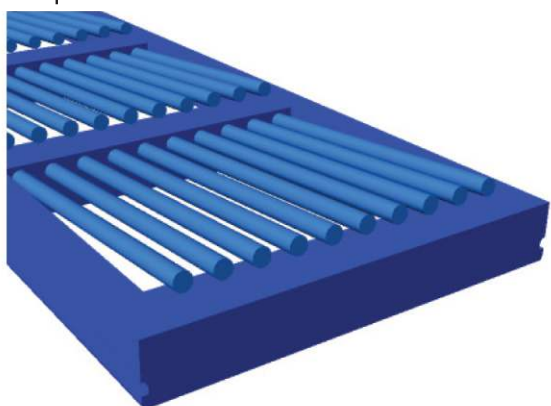

Harfové sitá

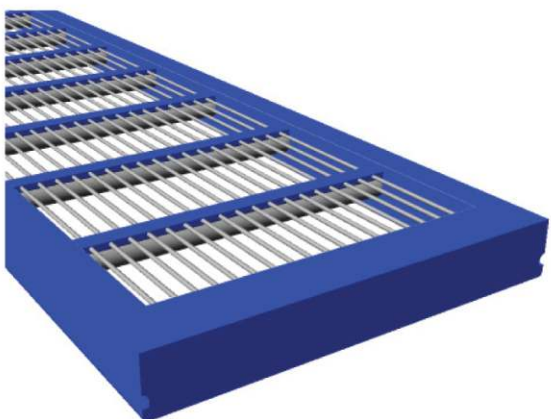
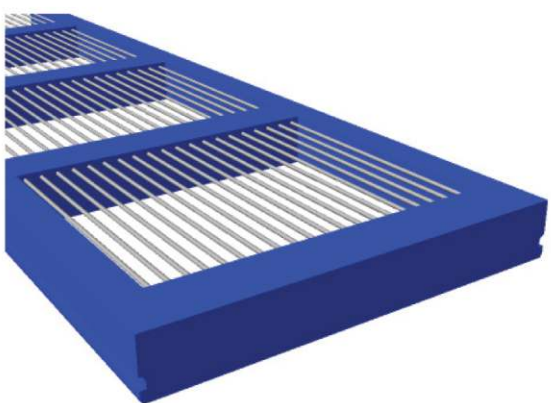

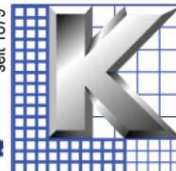

Kruhové otvory

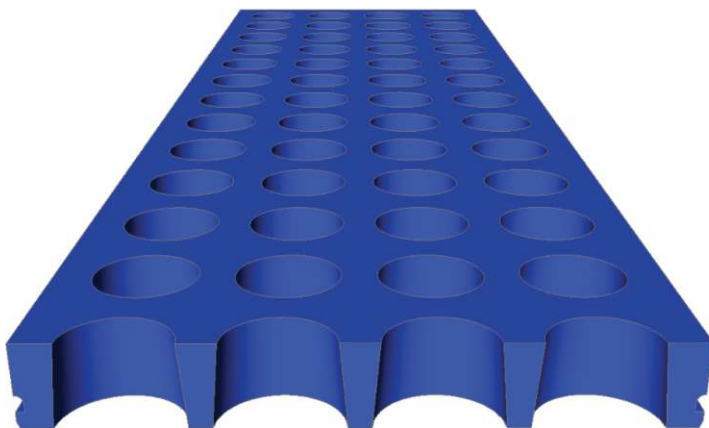
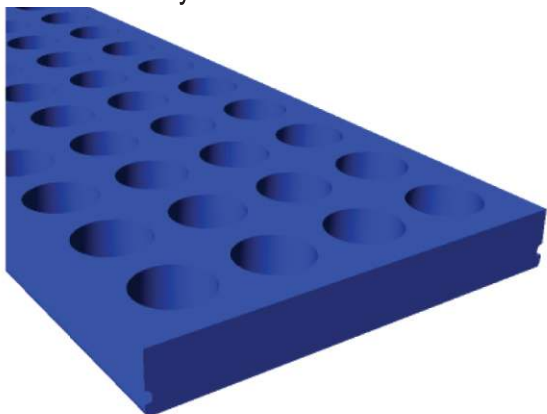

Ochranné rebrá

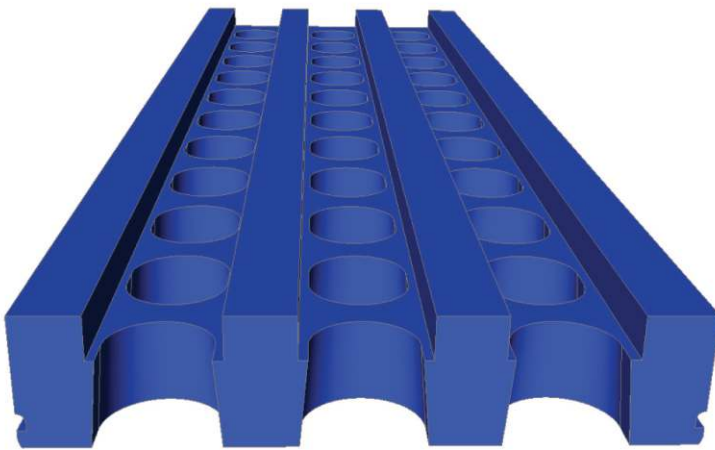
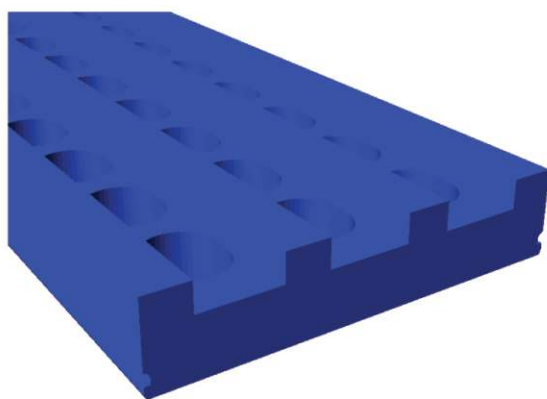

Vyloženie bubnových triediččov

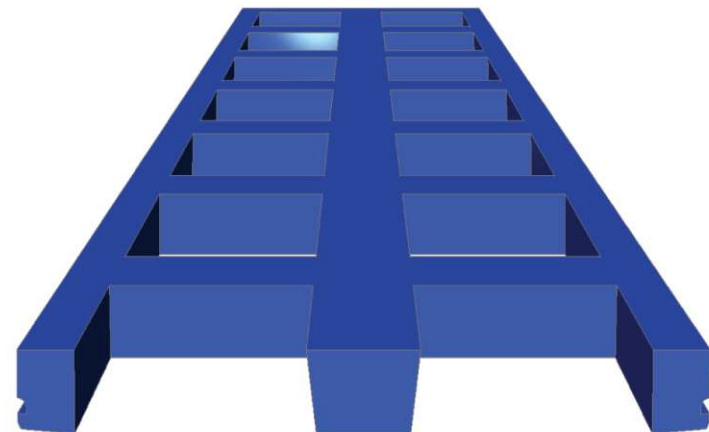
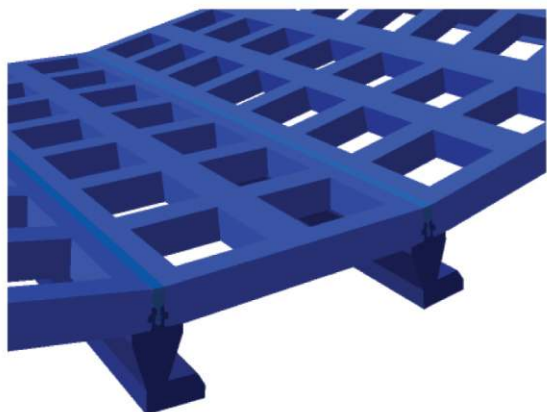

Duo (Kombinácia gima + PU)

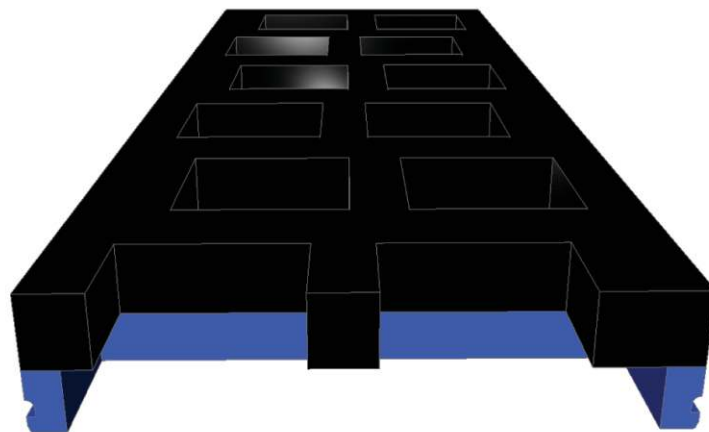
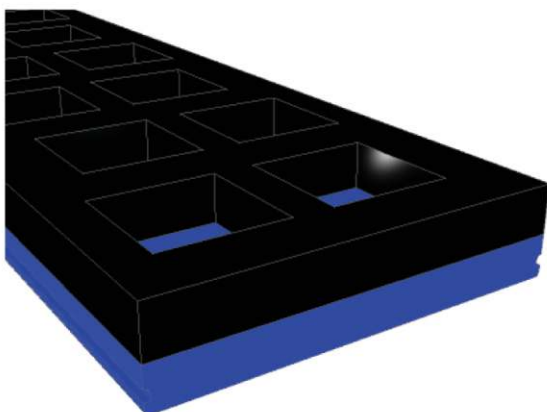



Tlakovo zvárané sitá

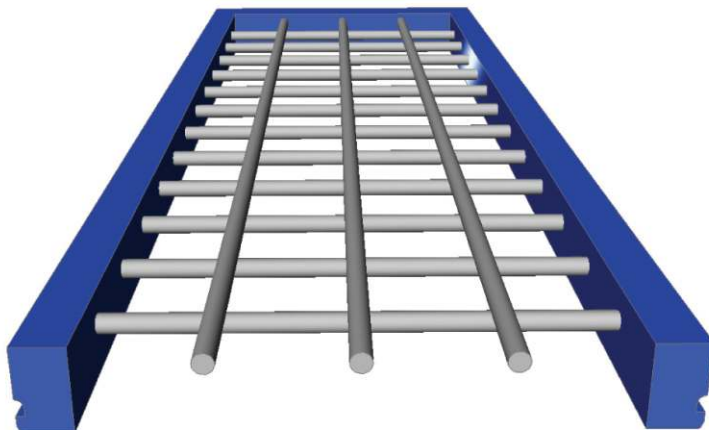
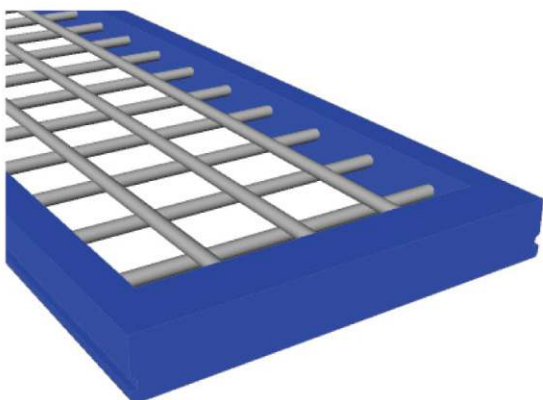

Jednostranne hladké sitá

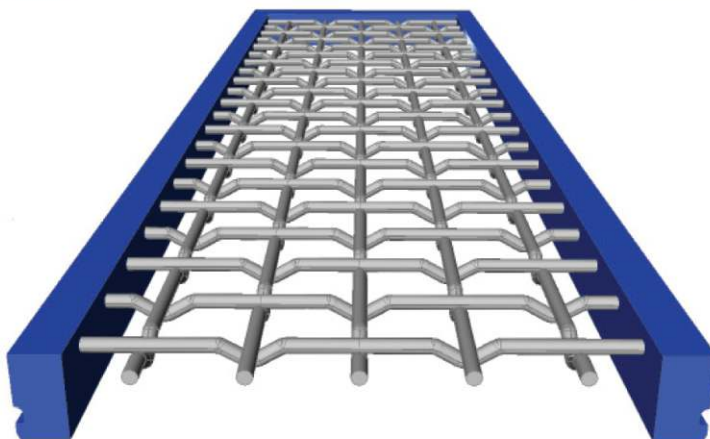
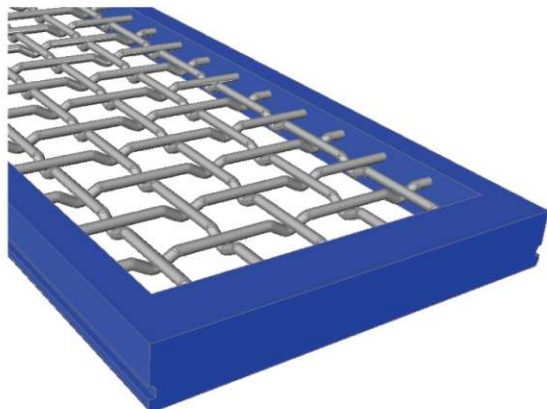

Festa-Stabil / Sitá s pravouhlými okami

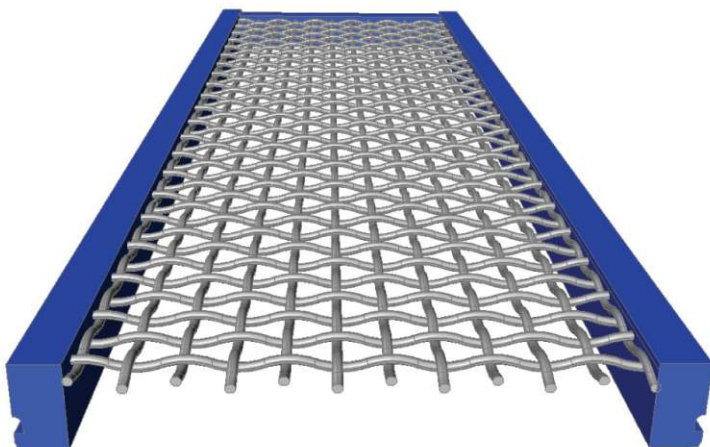
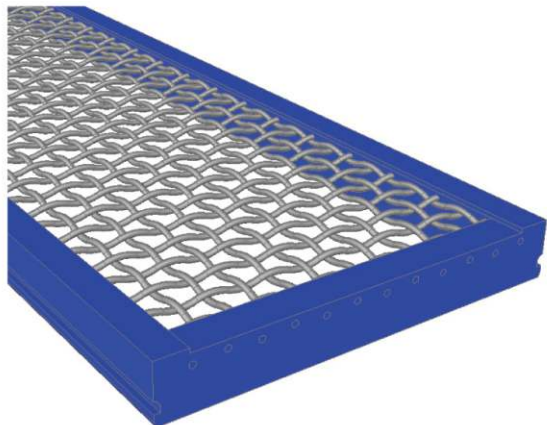

Serfesta-Harfe / Harfové sitá

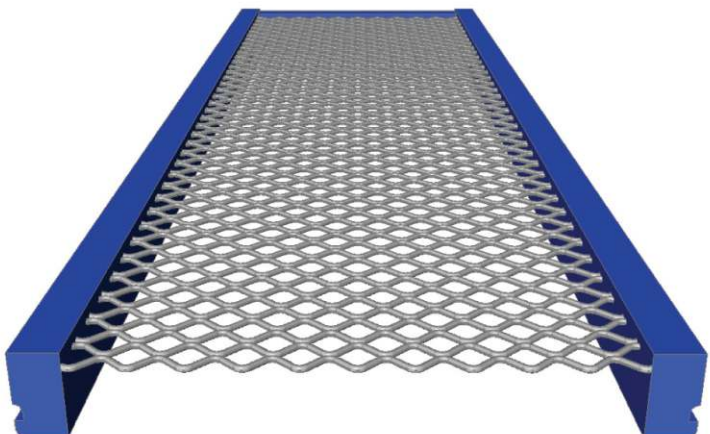
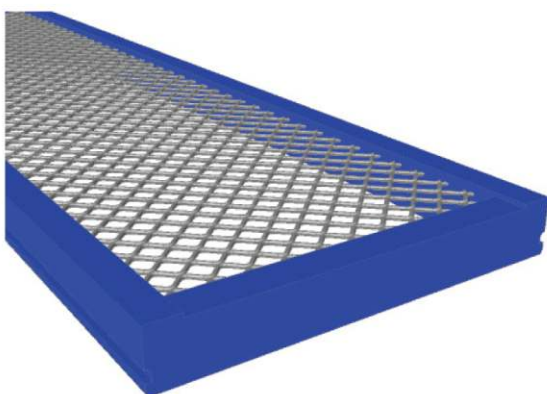

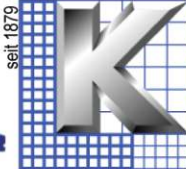

s ochranou nosníka

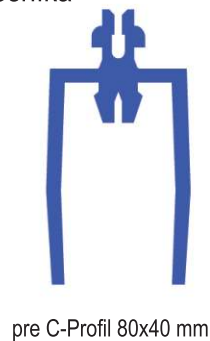
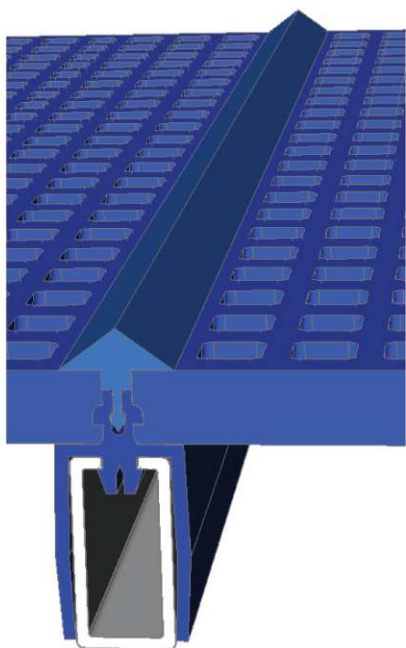

pre T nosník

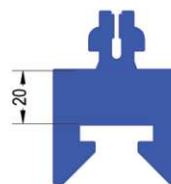
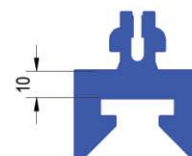
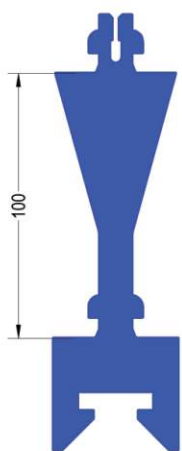
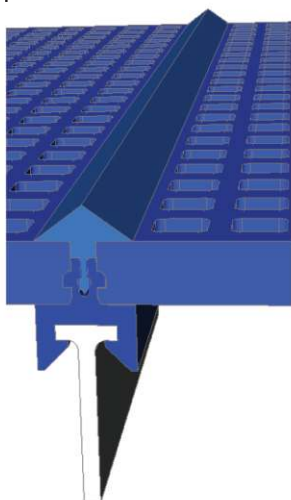

pre L nosník

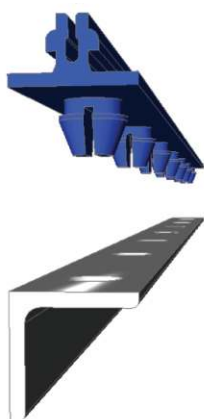

rozostup špičiek 150 mm



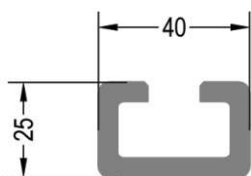
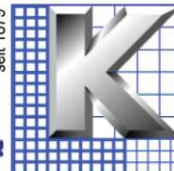

C-Profil
25x40 mm

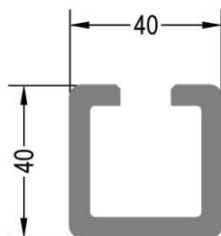

C-Profil
40x40 mm

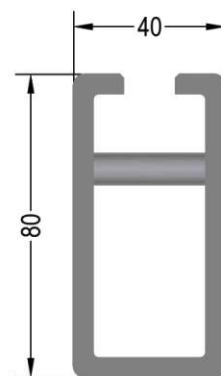

C-Profil
80x40 mm znitovaný

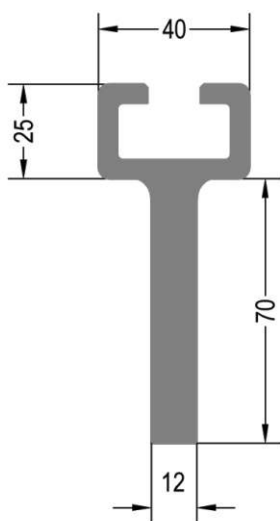

C-Profil 25x40 mm
s navarenou plochou
oceľou

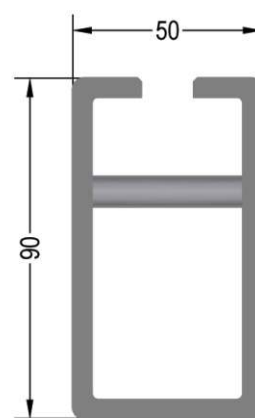

C-Profil
90x50 mm znitovaný

Príklady použitia:

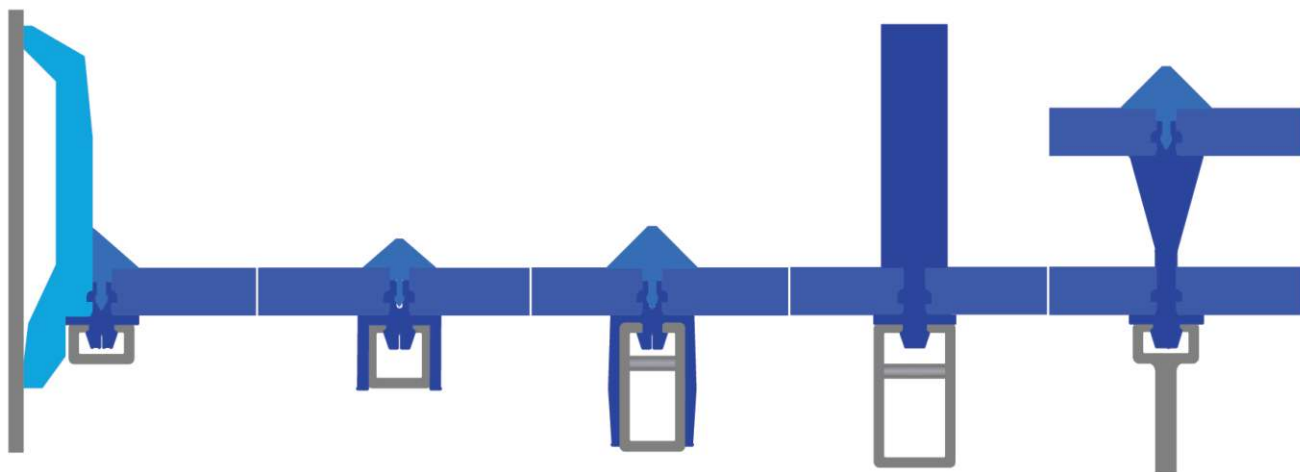

ClipTec® Program

PU - nosníky



Vomet, spol. s r. o.
Trstínska cesta 19, 917 01 Trnava
Slovenská republika
www.vomet.sk



seit 1879

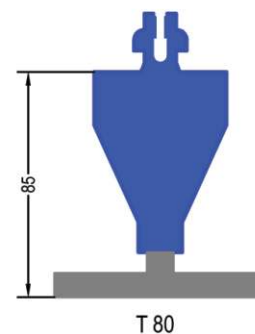
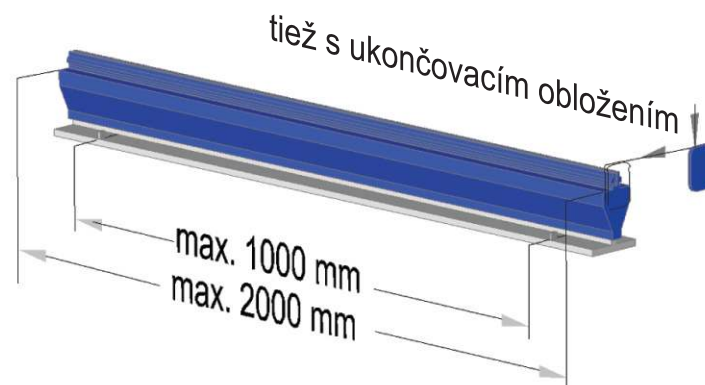
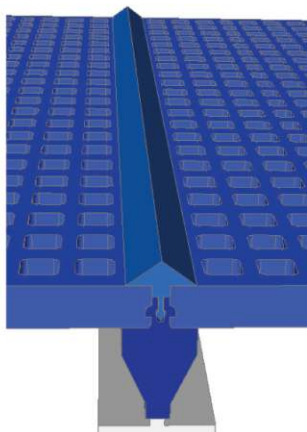
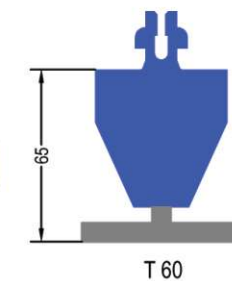
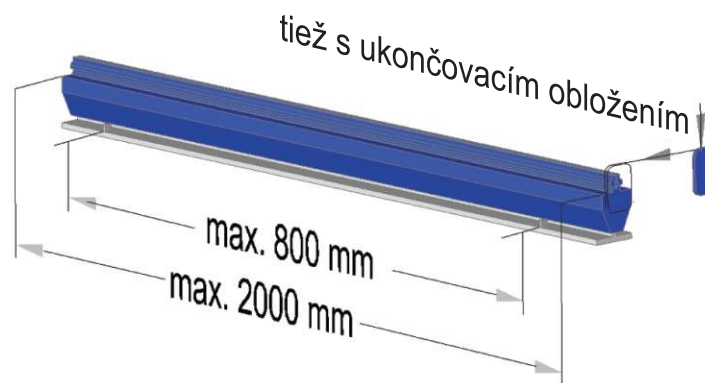
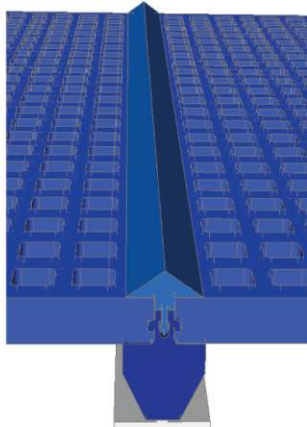
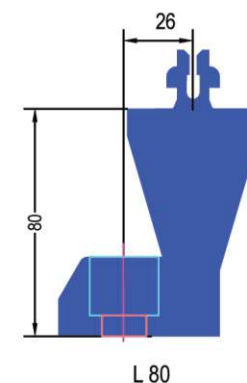
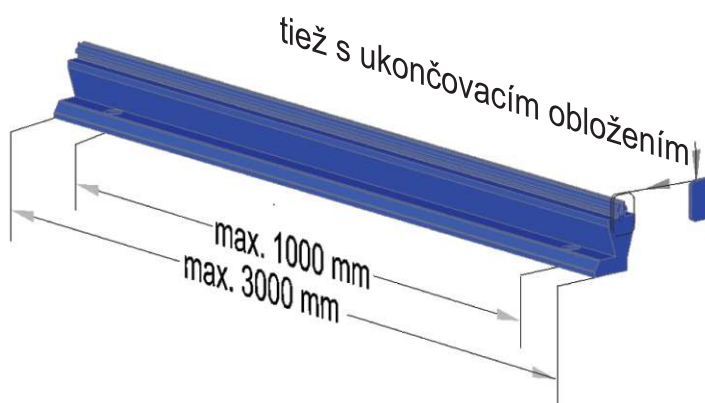
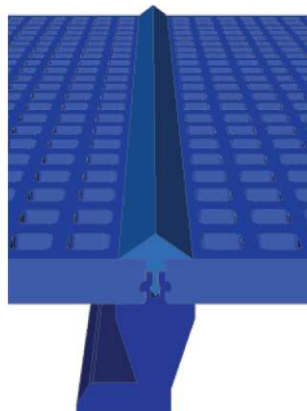
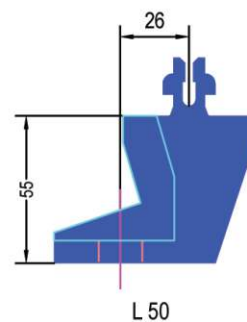
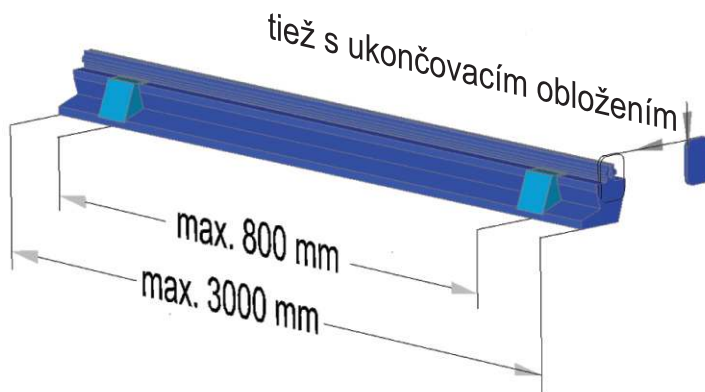
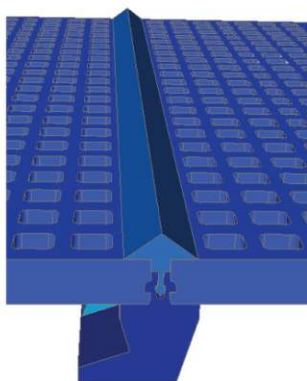
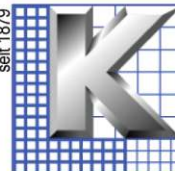

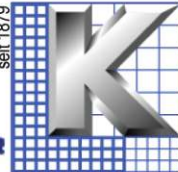

Príklady použitia:

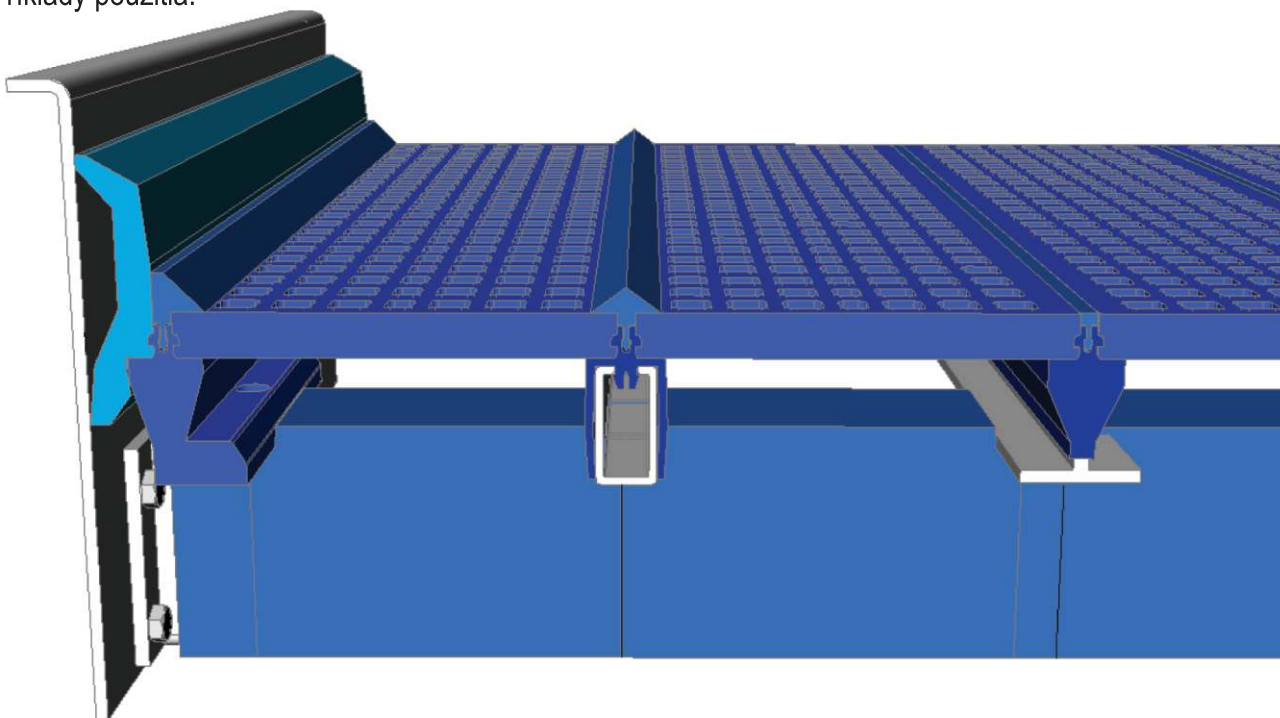

Štandard



Usmerňovač

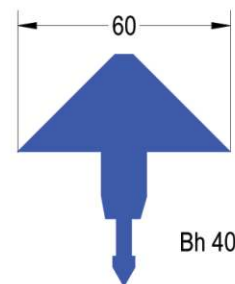
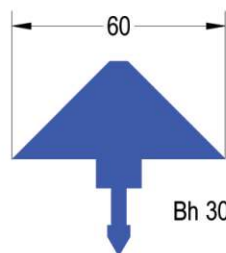
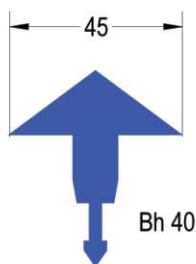
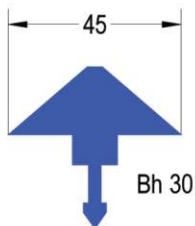

Krajový usmerňovač



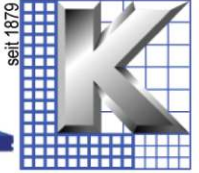

Integrované krajové lišty

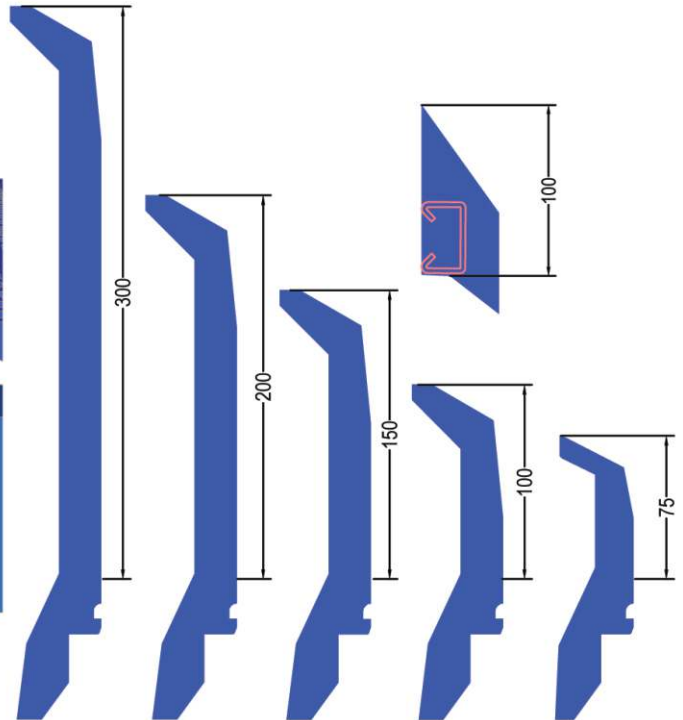
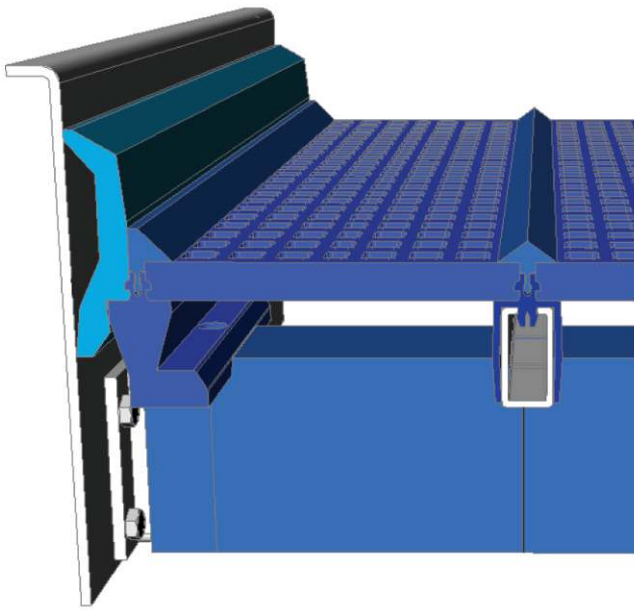

Skrutkované krajové lišty

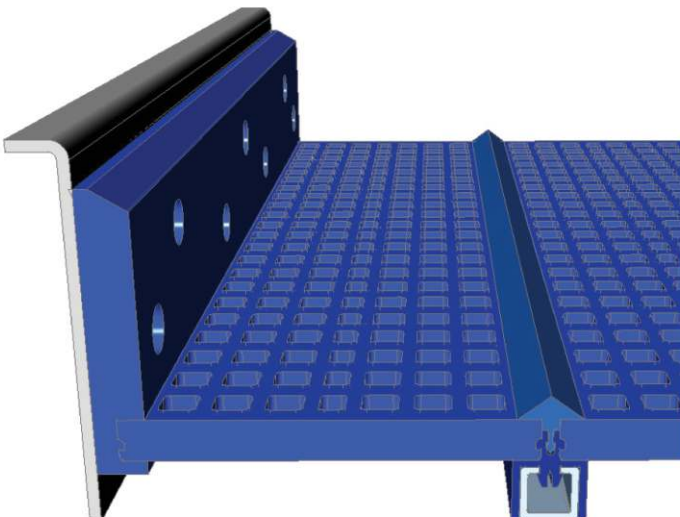
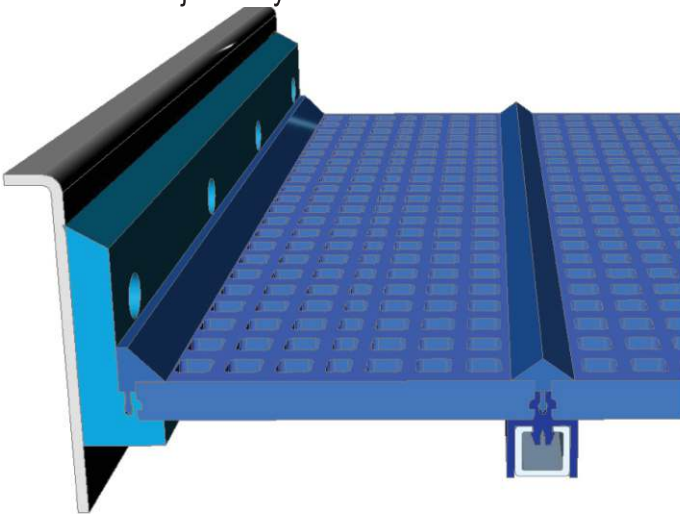

Ďalšie spôsoby na základe individuálnych požiadaviek.



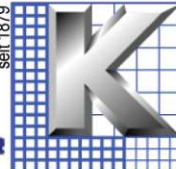

Ochranná plocha

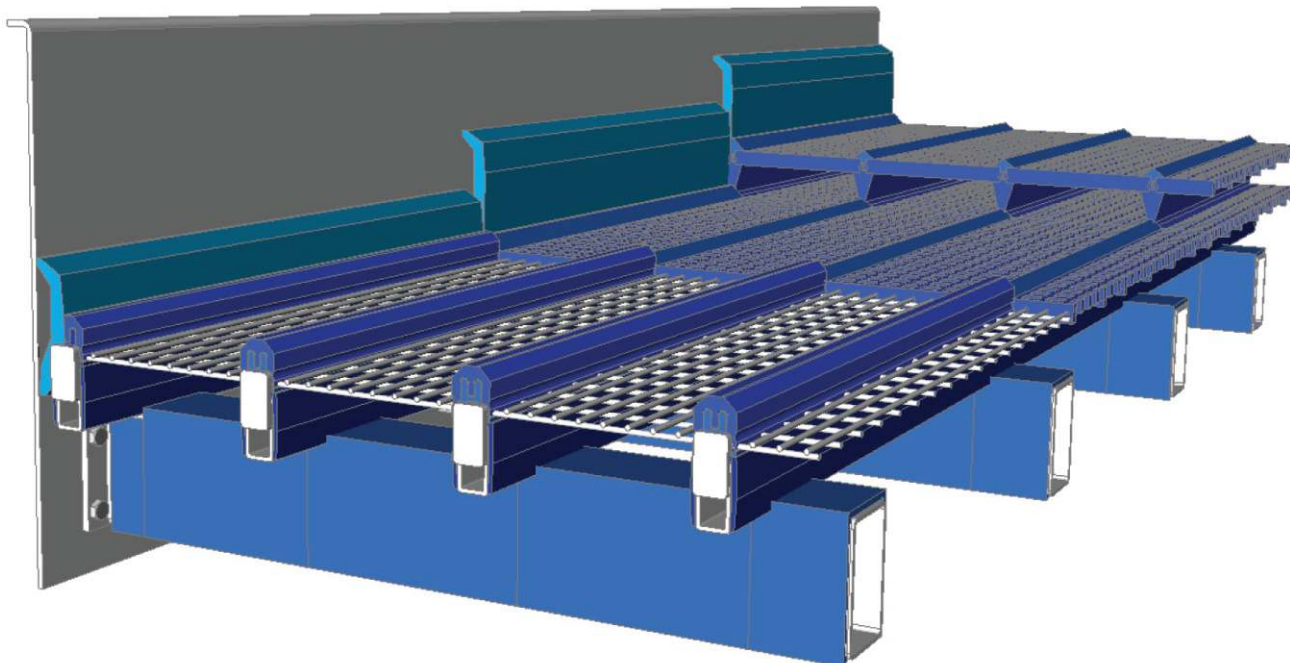

Detail ochrannej plochy

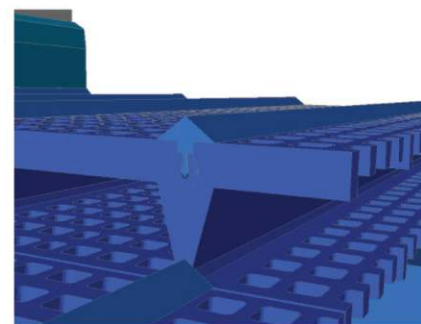

Triediaci bubon

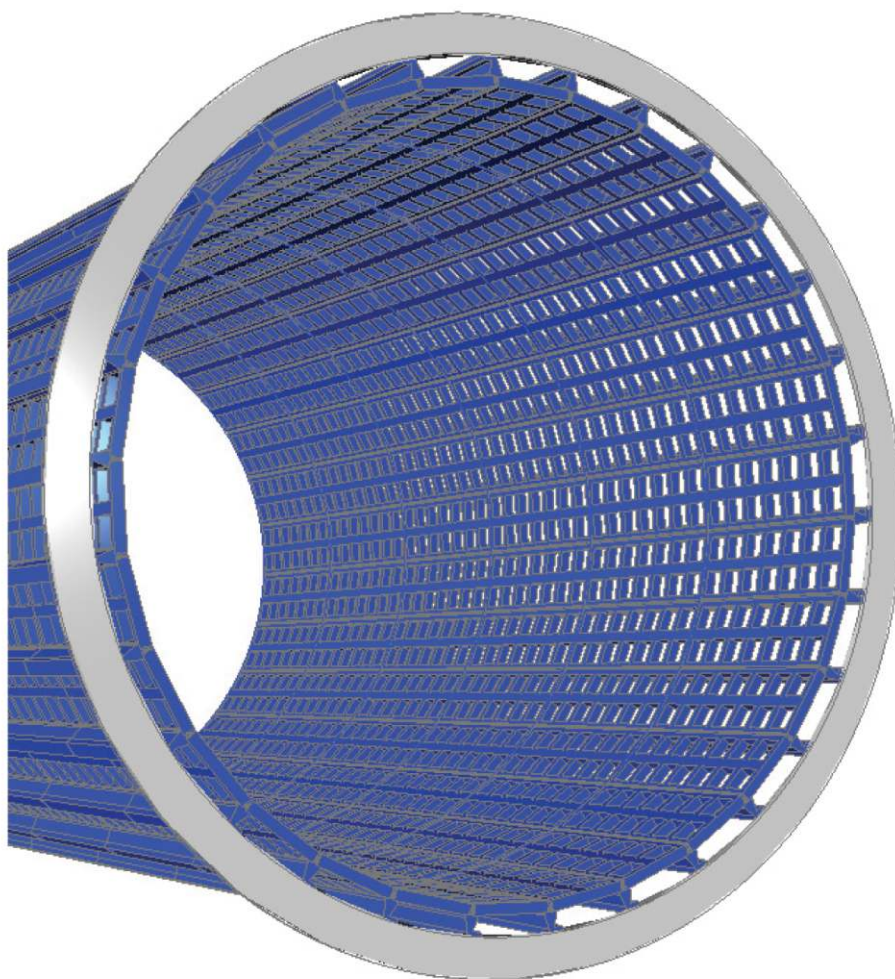

Detail bubna



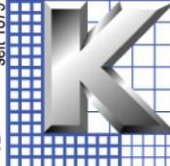

Krajová ukončovacia lišta výška 30 a 40 mm

Šírka 6 - 46 mm

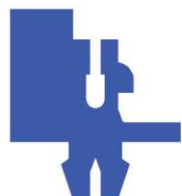

Krajový adaptér

Výška 30, 40, 50 mm

Šírka 20 - X mm

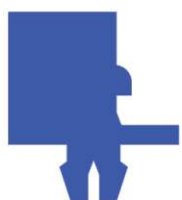

Krajový adaptér

Výška 30, 40, 50 mm

Šírka 20 - X mm



ClipClean® vyklepávacie gule

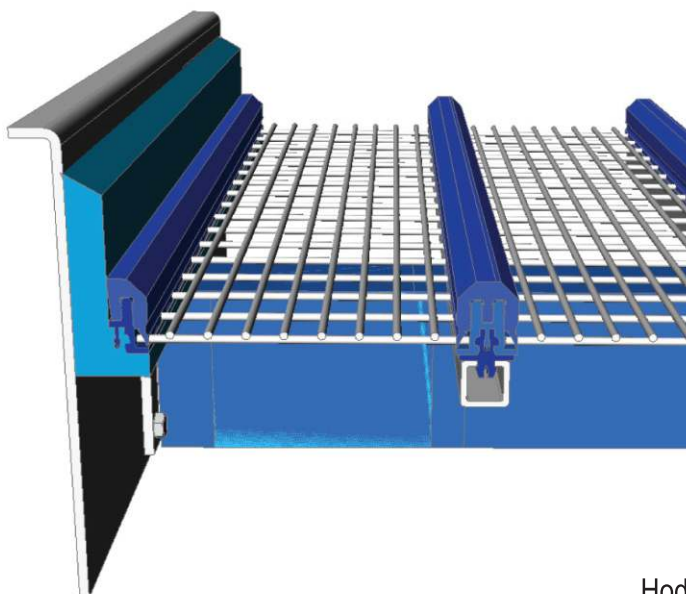

ClipTec® Drát - adaptéry

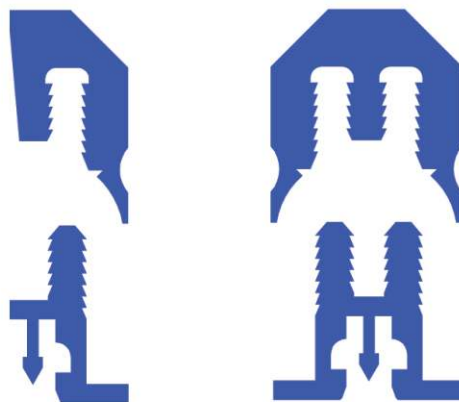

Hodí sa pre všetky ClipTec® adaptéry a ClipTec® nosníky.



Klinové krajové lišty

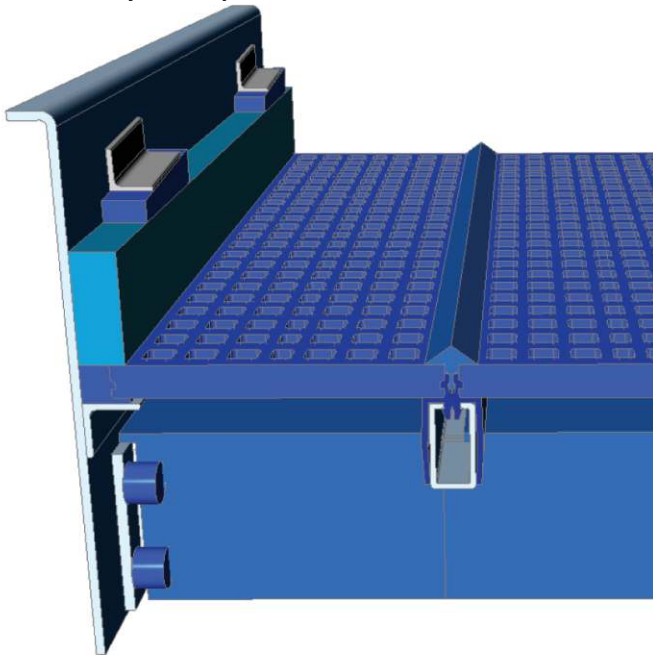

KWS

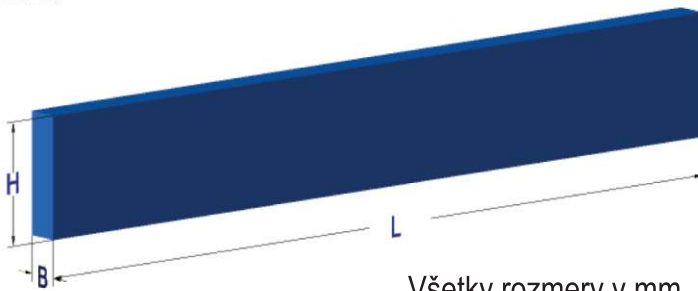

Všetky rozmery v mm

KBK

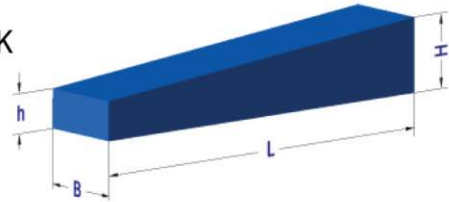

TYP	L	B	H / h
KBK 001	160	40	28/14
KBK 002	160	35	30/15
KBK 003	160	45	45/25
KBK 004	160	40	30/20
KBK 005	180	40	35/20
KBK 006	230	50	55/35
KBK 007	180	40	55/45
KBK 008	120	35	35/25
KBK 009	200	40	35/25
KBK 011	230	40	55/40
KBK 012	200	40	40/20
KBK 013	160	40	22/12
KBK 014	200	45	35/20
KBK 015	165	40	45/25
KBK 022	150	40	35/25
KBK 023	160	40	32/20
KBK 024	250	40	63/41
KBK 025	200	40	45/40
KBK 026	190	30	45/30
KBK 027	135	40	32/6
KBK 028	250	50	50/25

TYP	L	H	B
KWS 75	1000	75	40
KWS 100	1000	100	40
KWS 150	1000	150	40
KWS 200	1000	200	40

Sprchovacie trysky Ø 4, 5, 6, 7, 9, 11



Ochrana nosníkov z PU

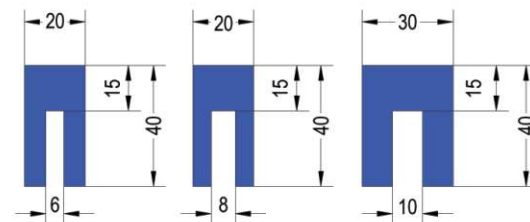

Iné rozmery na základe dopytu, max. dĺžka 2,5 metra.

z gummy

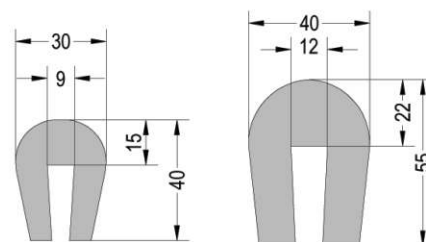

tesniaci profil
zo silikónu
alebo z gummy

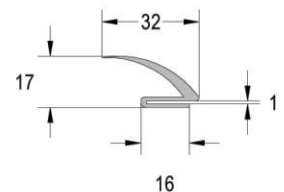

Rolky á 20 metrov.



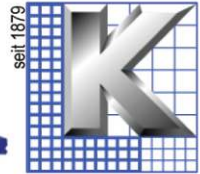

Spájacie spomaľovacie lišty

KH	30	30	30	40	40	40	40	50
H	20	30	40	20	30	40	60	40
L	300	300	300	300	300	300	300	300

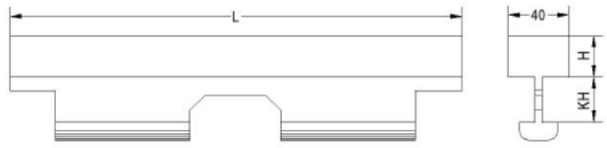

Ďalšie na základe dopytu.

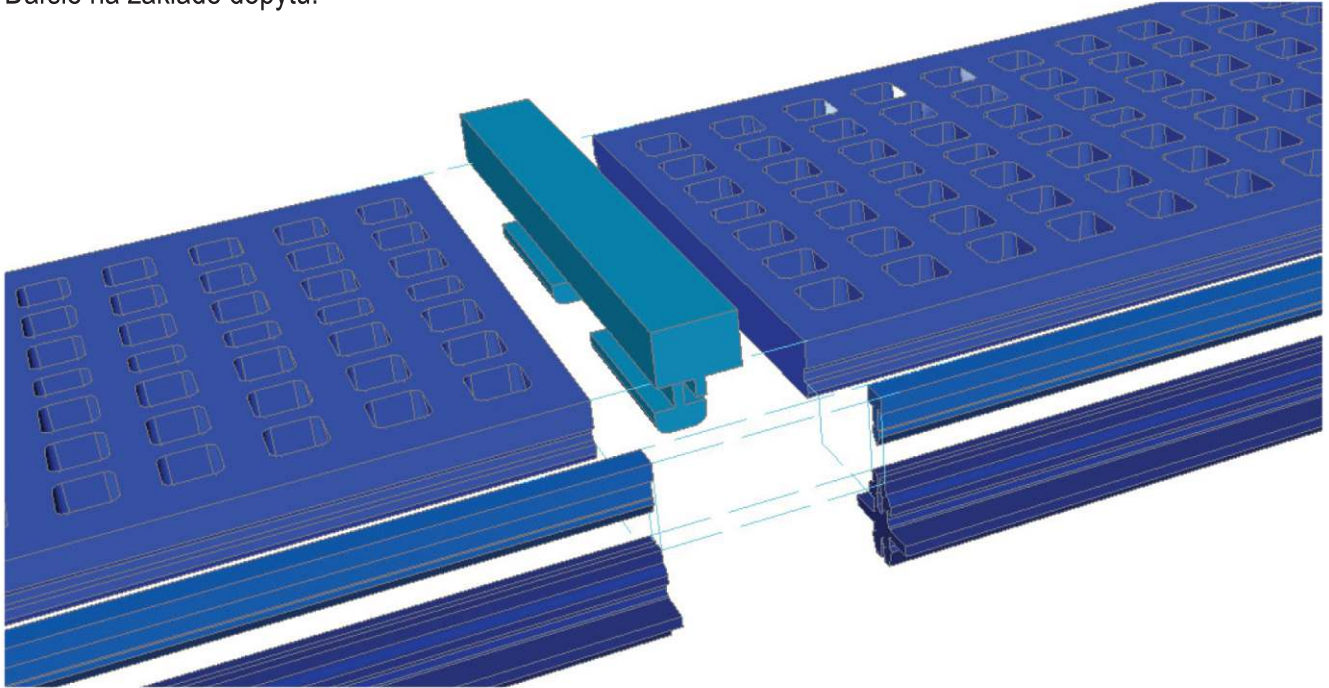

Zaliate spomaľovacie lišty

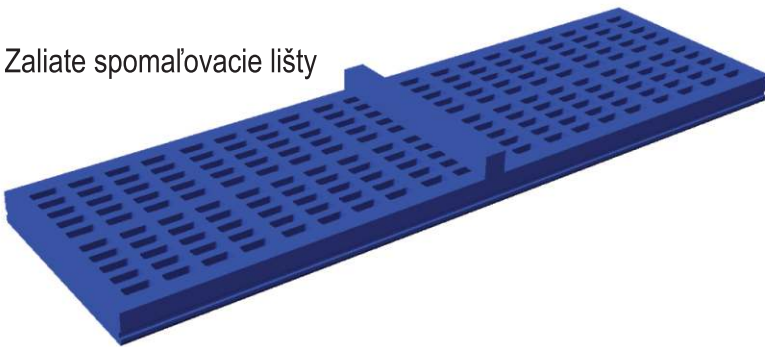

Spomaľovacie lišty k prilepeniu, alebo priskrutkovaniu.

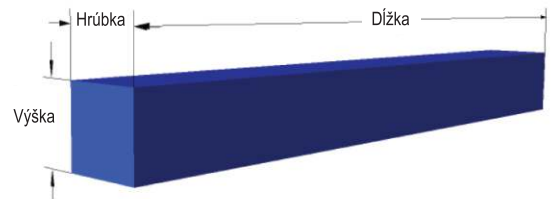

Spomaľovač k prilepeniu, alebo priskrutkovaniu.

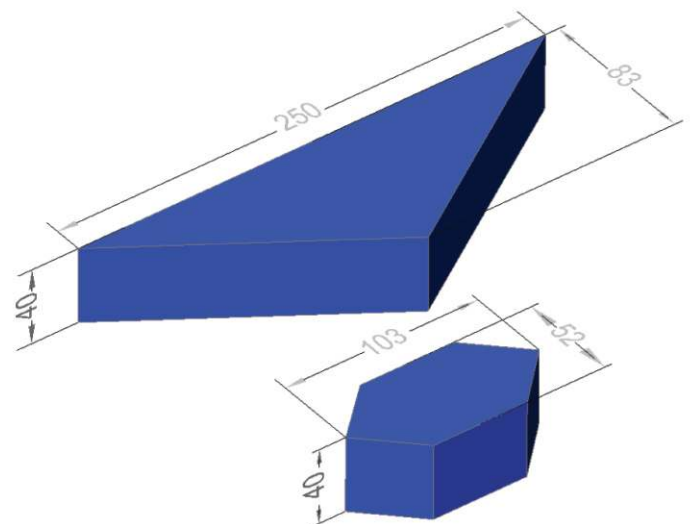

Všetky rozmery sú uvedené v „mm“.



Ochrana proti oteru

HEA-HEB Ochrana nosníkov



Vomet, spol. s r. o.
Trstínska cesta 19, 917 01 Trnava
Slovenská republika
www.vomet.sk

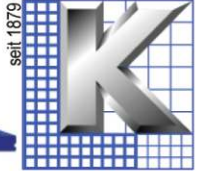

Príklady použitia:

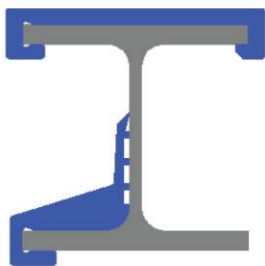
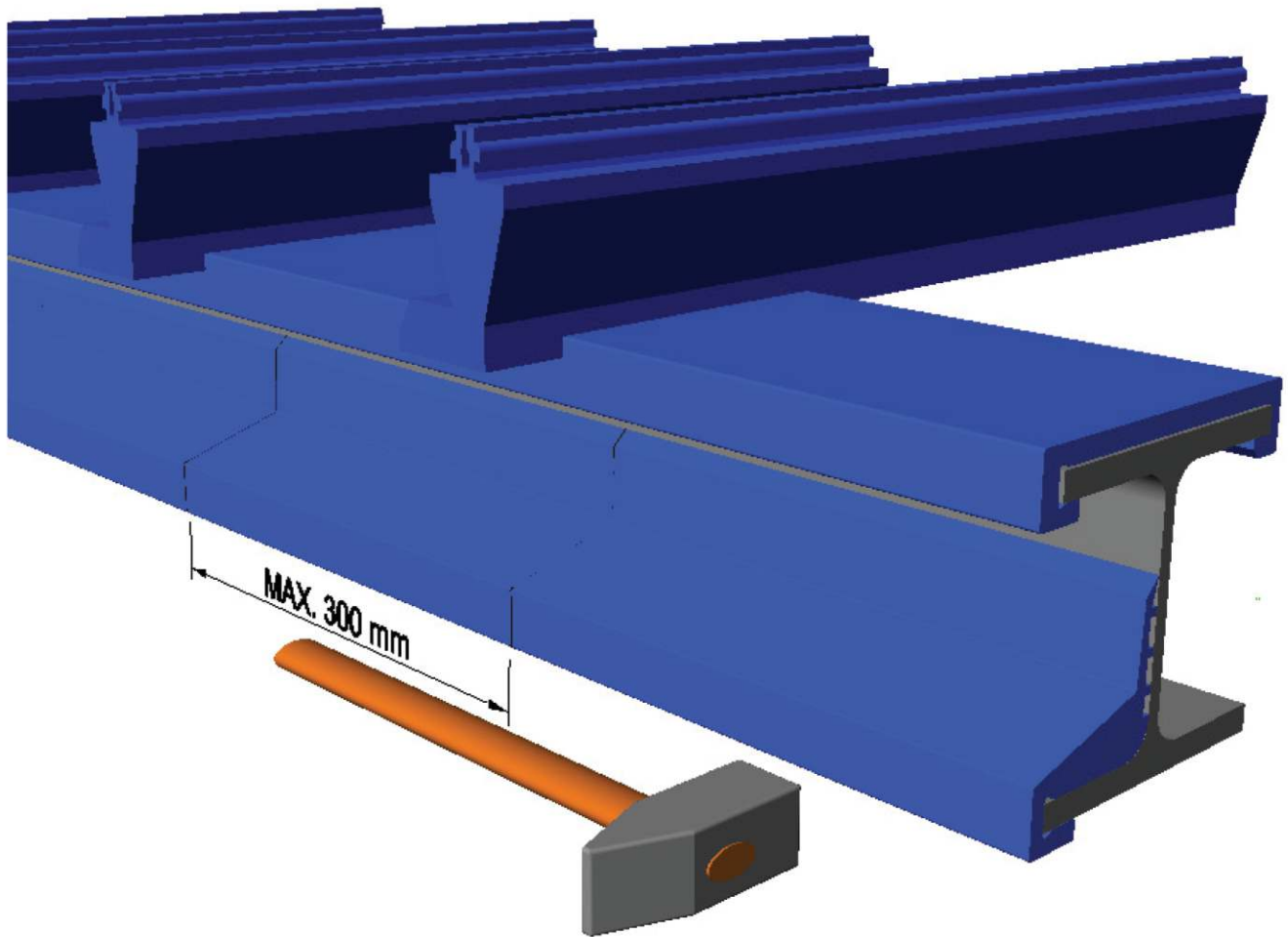

HEB a HEA 140

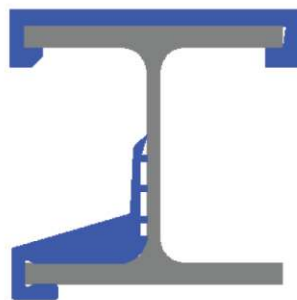

HEB 160

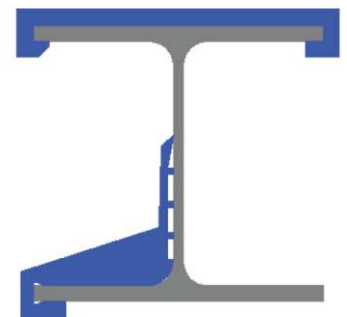

HEA 180

Ďalšie rozmery na základe dopytu.



Ochrana proti oteru

Ochrana štvorhranných nosníkov



Vomet, spol. s r. o.
Trstínska cesta 19, 917 01 Trnava
Slovenská republika
www.vomet.sk

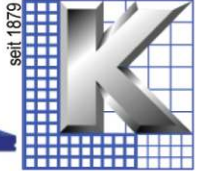

Príklady použitia:
Dĺžka modulu 300 mm

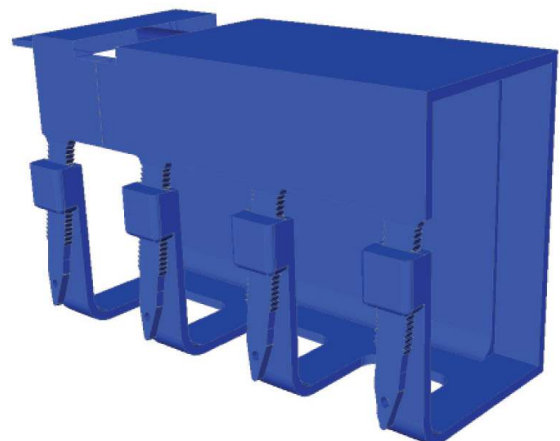
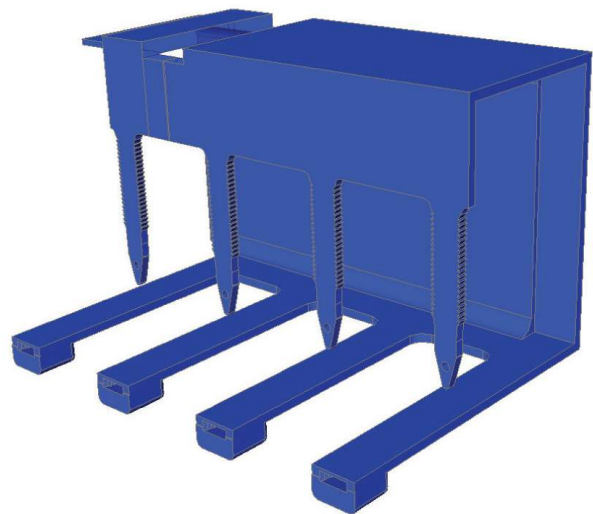
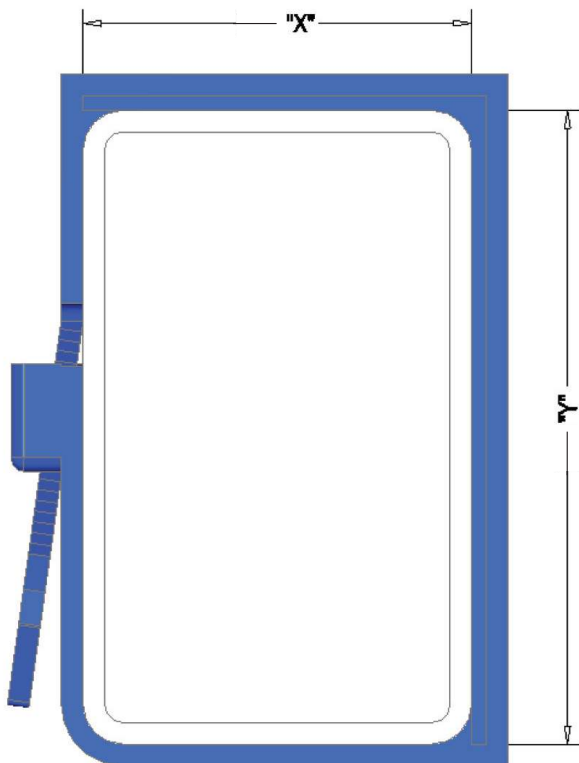
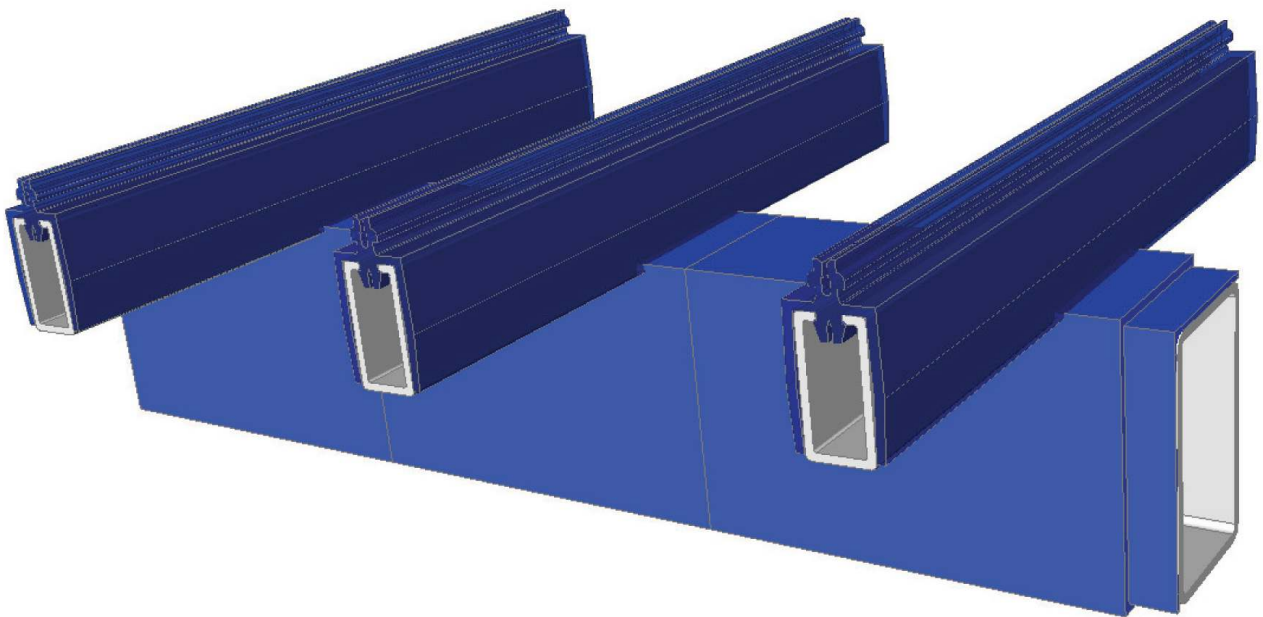

Ďalšie rozmery na základe dopytu.



Ochrana proti oteru

Ochrana rúrových nosníkov



Vomet, spol. s r. o.
Trstínska cesta 19, 917 01 Trnava
Slovenská republika
www.vomet.sk



seit 1879

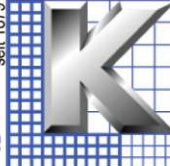

Príklady použitia:

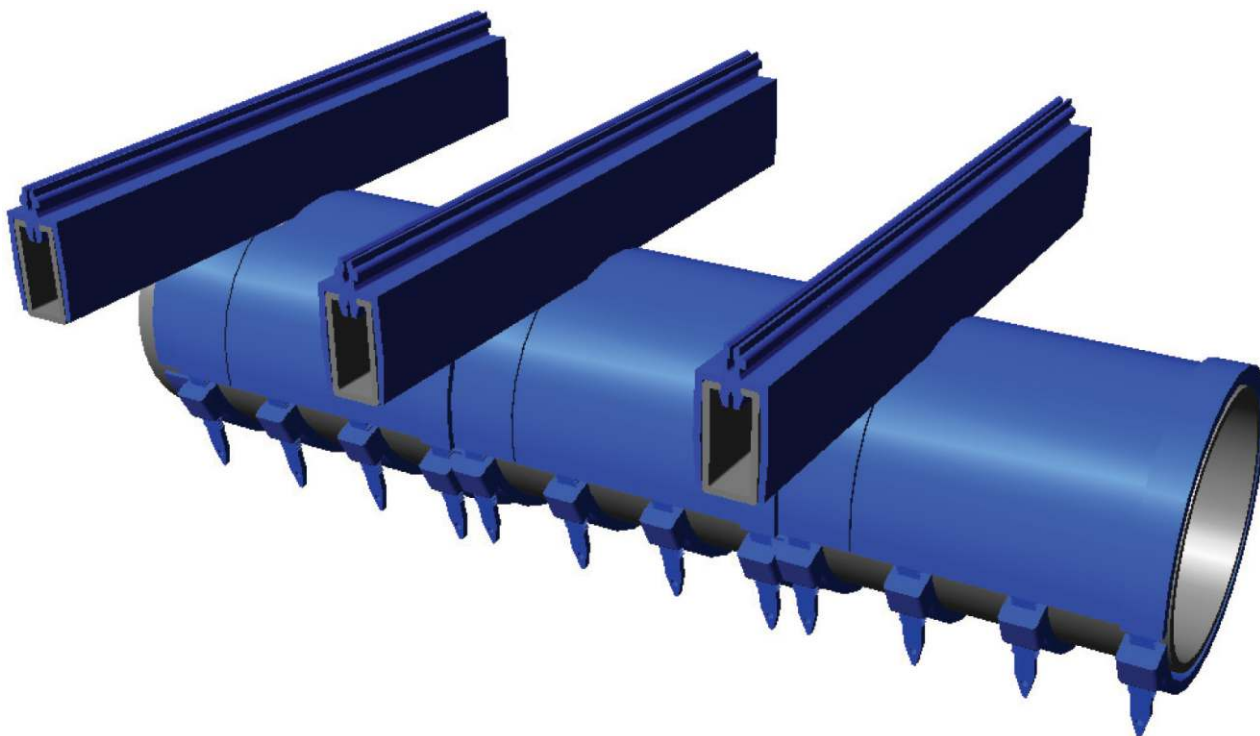

Ochranný element
pre priemer rúry 300 mm.

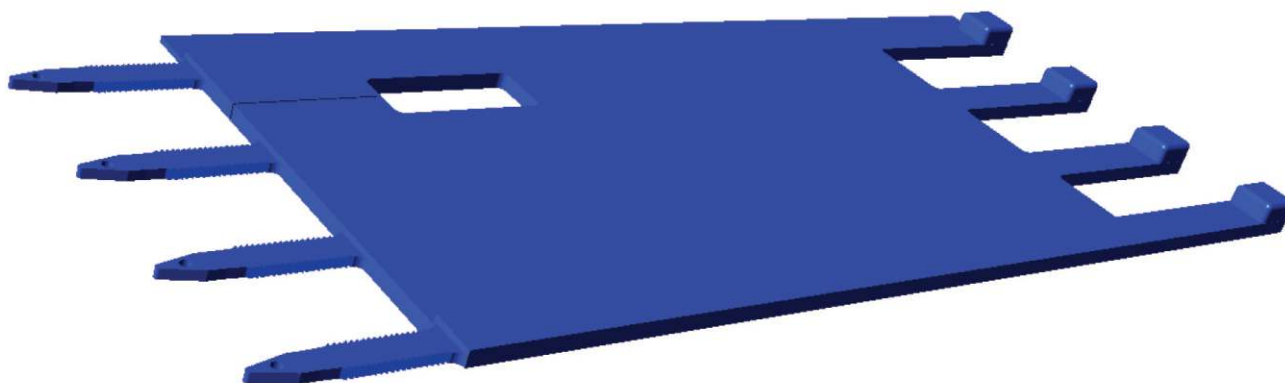
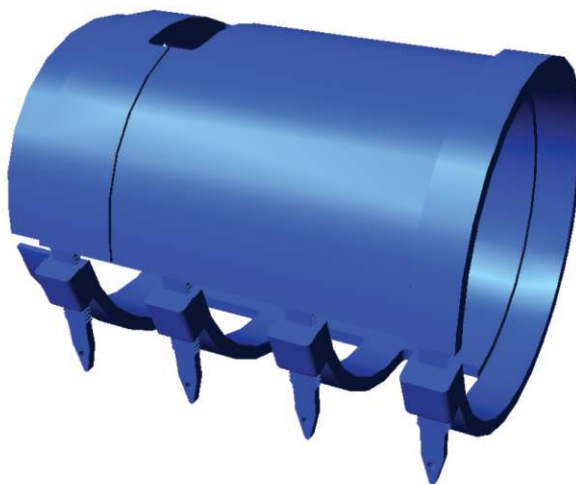

Ostatné priemery rúr na základe dopytu.



Príklady použitia:

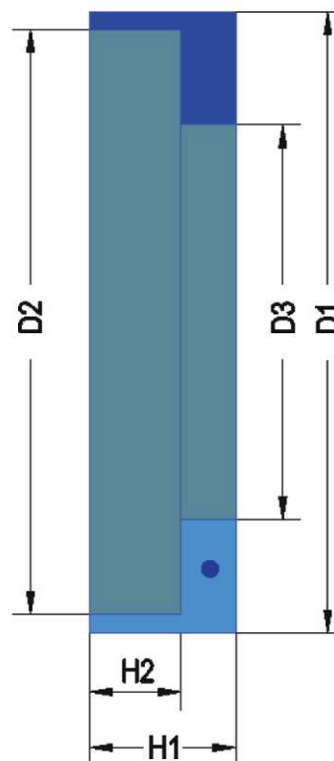
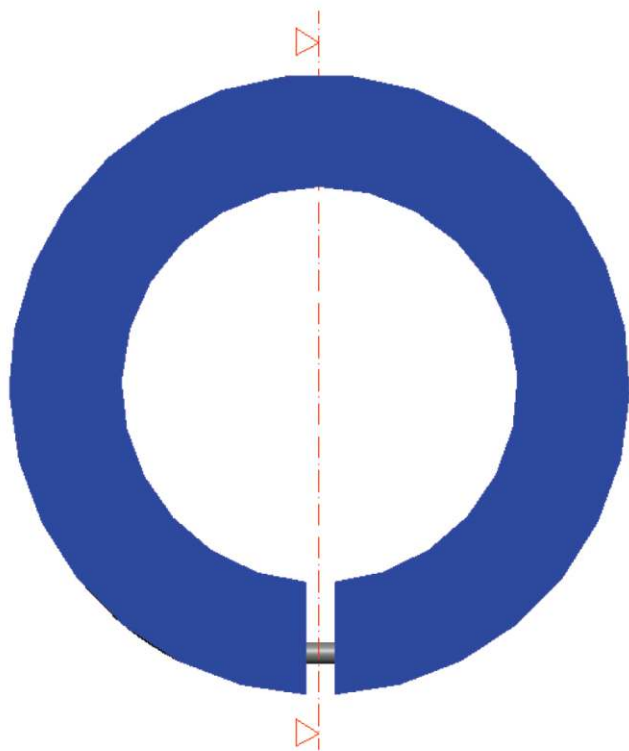
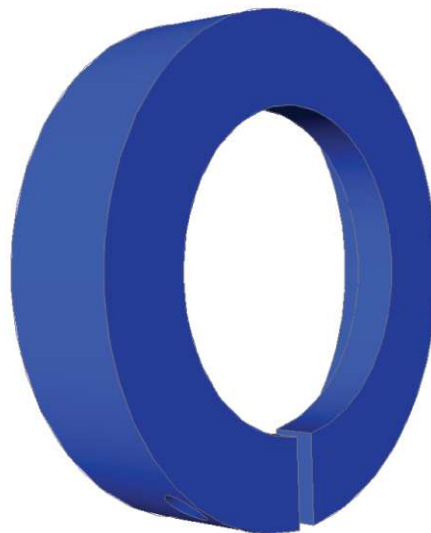
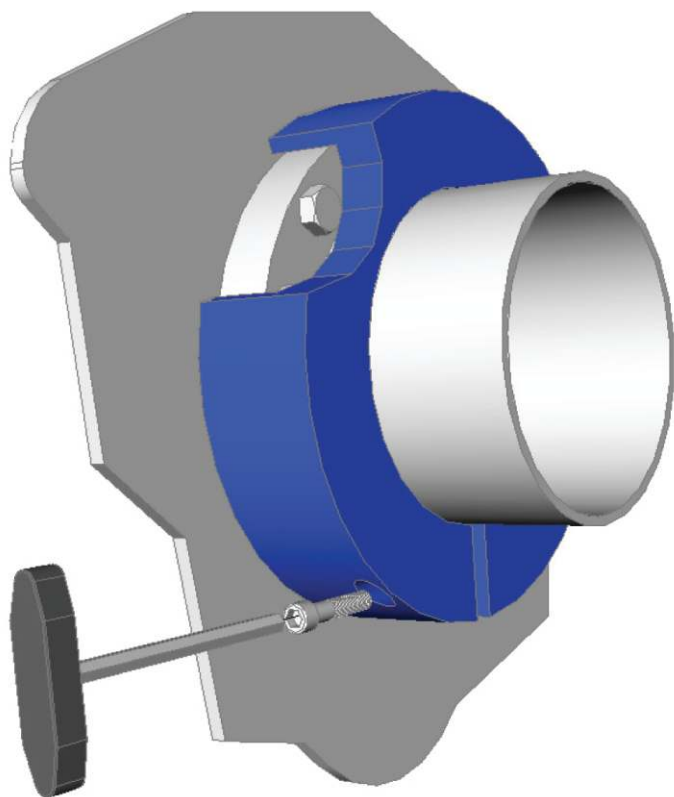

Ďalšie rozmery na základe dopytu.



Ochrana proti oteru

Ochrana dištančných rúr



Vomet, spol. s r. o.
Trstínska cesta 19, 917 01 Trnava
Slovenská republika
www.vomet.sk



seit 1879

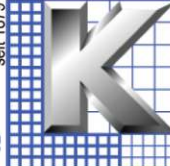

Príklady použitia:

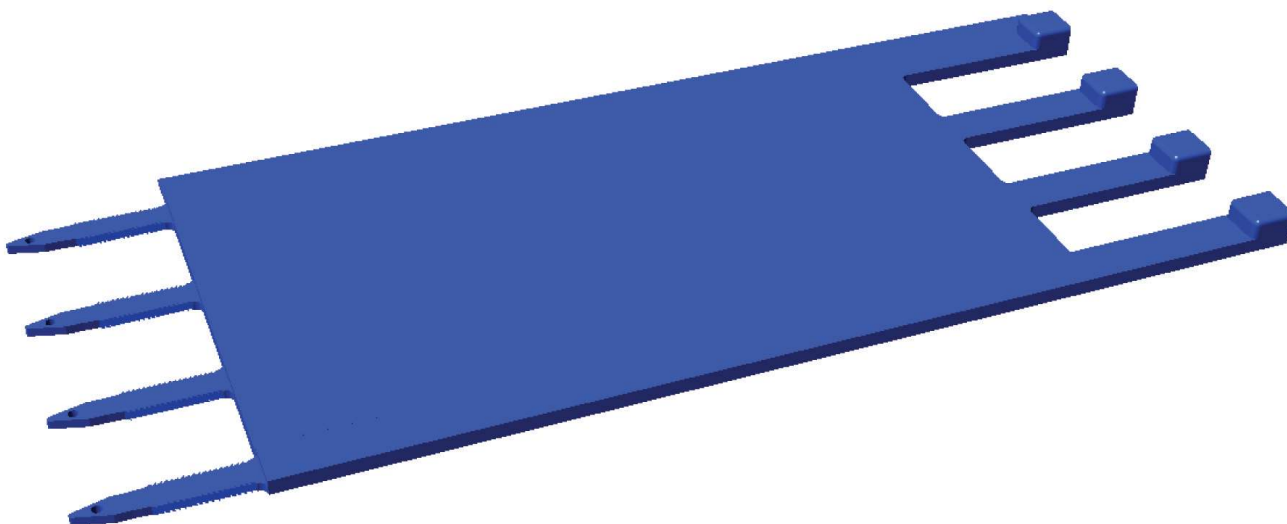
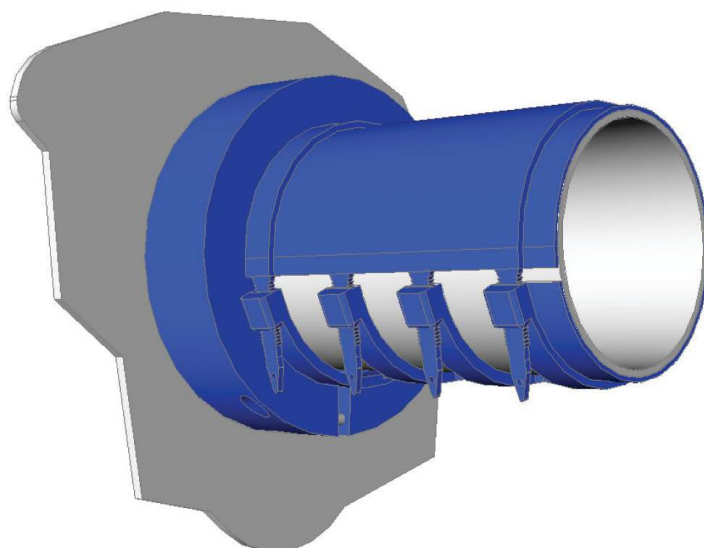
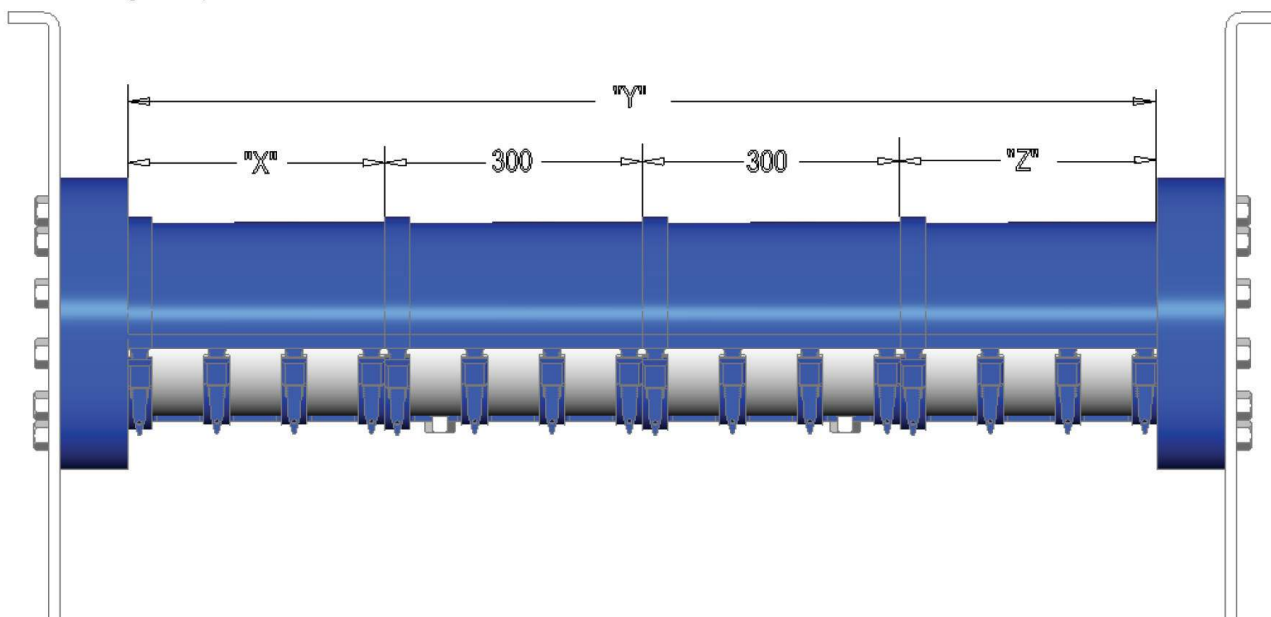

Príklady použitia:

Označenie	Dĺžka dielca v mm	Dĺžka v mm
KML 000002	122,5/250/250/250/122,5	995
KML 000003	147,5/350/350/147,5	995
KML 000004	122,5/375/375/122,5	995
KML 000005	147,5/350/350/147,5	995

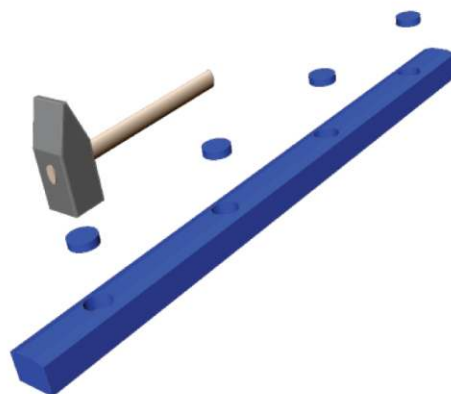

Upevňovacie valce

TYP	A	B	C	D	H	pre hmotnosť M
KBT 000002	18	35	75	-	35	16
KBT 000003	18	45	80	-	45	16
KBT 000004	18	45	100	-	45	16
KBT 000005	21	45	80	-	45	20
KDT 000002	14	35	80	33	45	12
KDT 000003	14	35	100	48	40	12
KDT 000004	14	40	148	50	55	12
KDT 000005	18	40	148	50	55	16

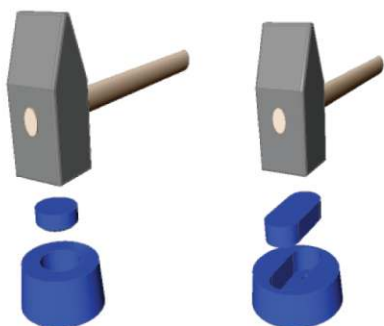

KBT

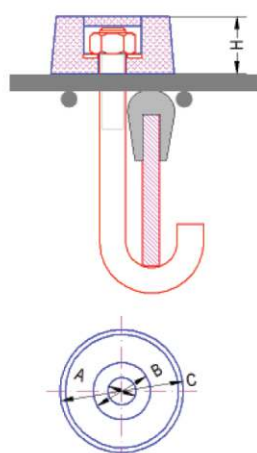

KDT

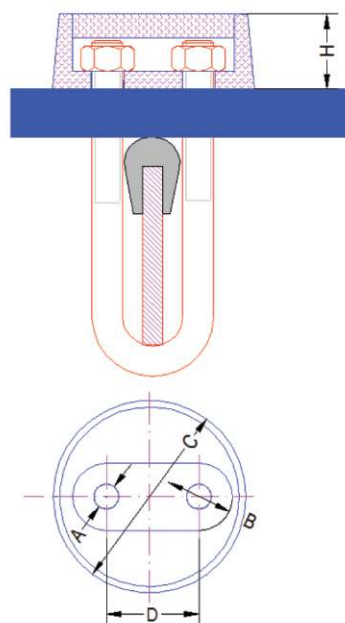

Ozubené retardéry

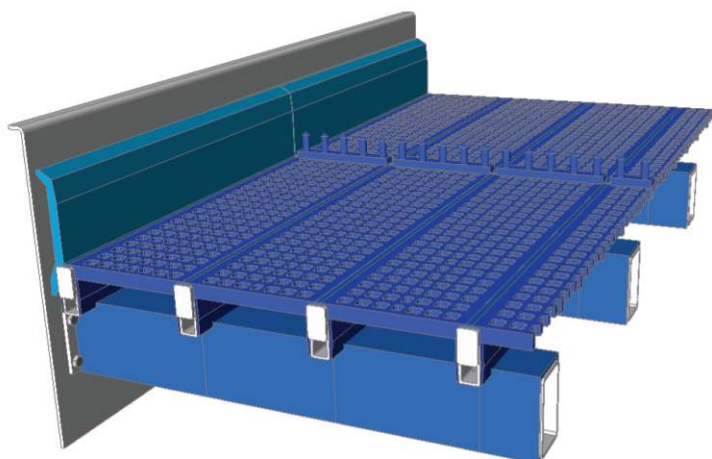

Rozm. 150x40x20 hr. 35

Rozm. 280x40x20 hr. 35

Rozm. 280x40x20 hr. 55

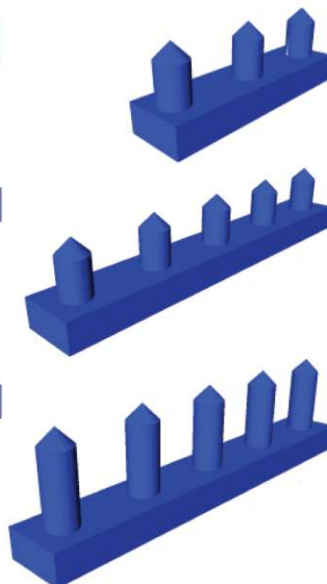

Všetky rozmery sú uvedené v „mm“.



Prstový systém

Prstové sítá a prstový nosník

Príklady použitia:

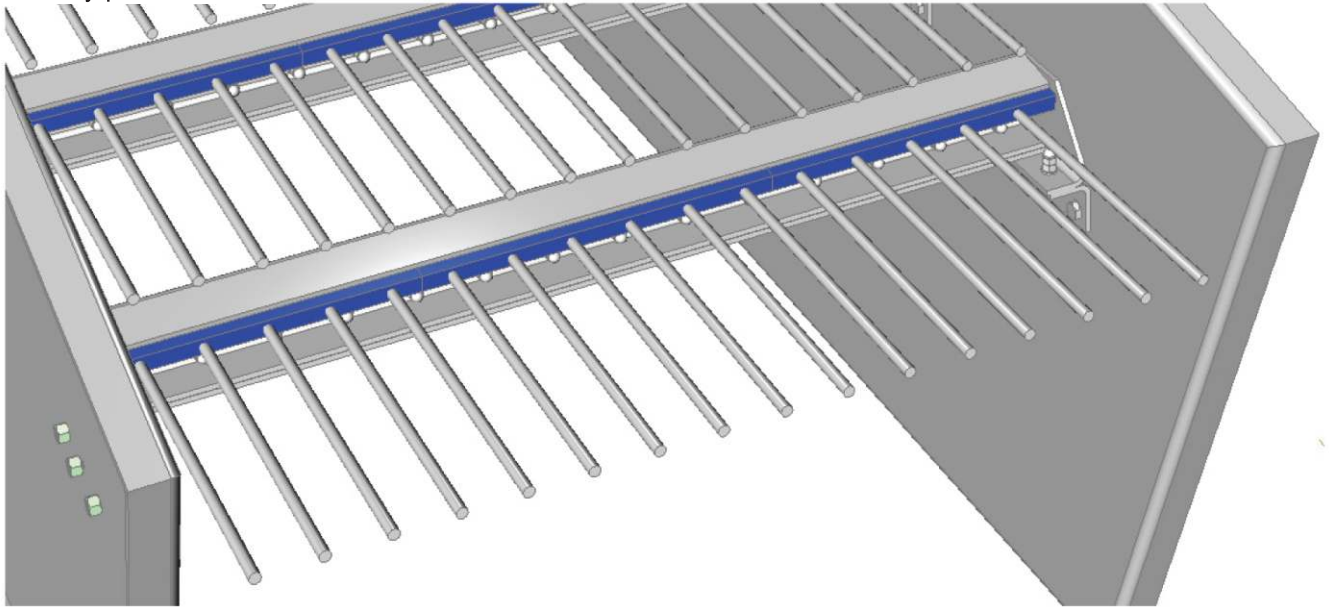

Prstový modul

pre mimoriadne pracovné podmienky

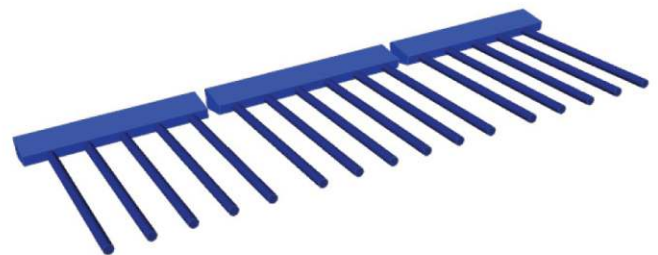
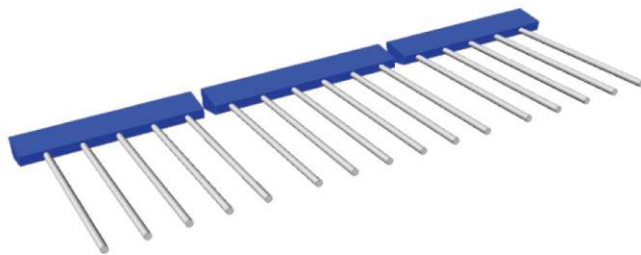

napr. pre triedenie skla-presadené prstové sítá

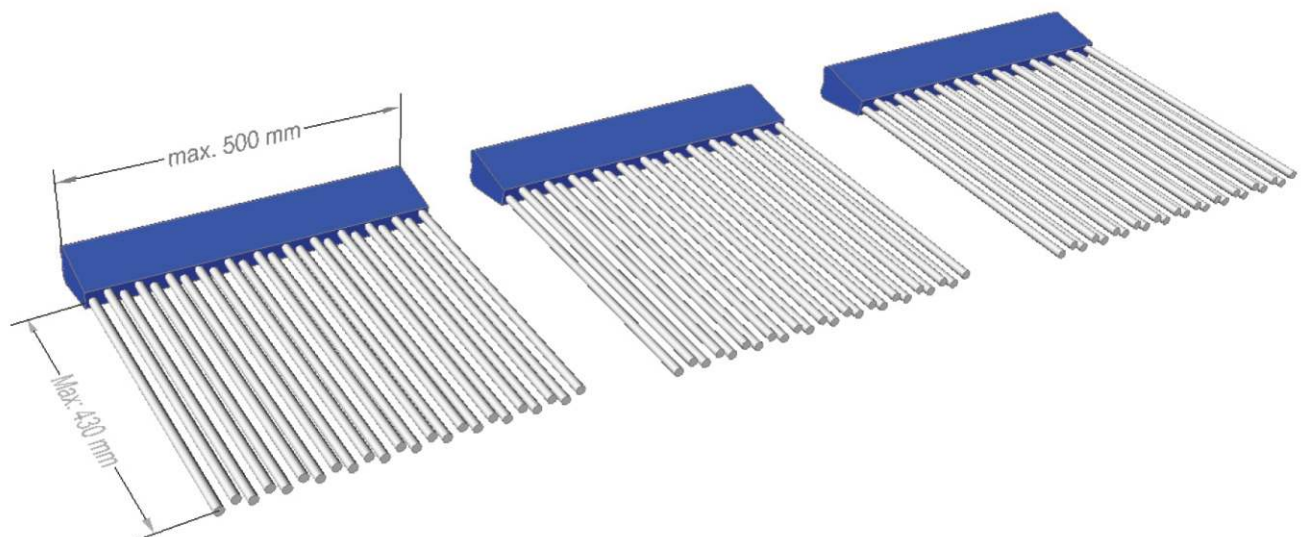

Dôležité hraničné údaje pre prstové sítá:

- max. otáčky triediaceho stroja
- max. veľkosť štrbiny
- max. dĺžka drôtov
- zadanie podľa možnosti kízavé
- nemožnosť ostrého triedenia

Veľkosť štrbiny a priemeru drôtu na základe dopytu



Uni-Step-Adaptér

Adaptér pre schodové usporiadanie sitových modulov

Príklady použitia:



Charakteristika: Vysoká životnosť; nízke prevádzkové náklady vzhľadom na lepšie otáčanie triedeného materiálu; lepší triediaci účinok; jednoduchá montáž.

Svetlosť otvoru: 2,5 mm - 130 mm.

Stavebná výška: 30 mm a 40 mm.

Materiál: Polyuretan 45-90° Shore.

Vonk. rozmery: Štandardné rozmery 300 mm x 600 mm, šírka 300 mm variabilná



Drôtený-Adapt-System

Pre inštaláciu drôtených plôch a dierovaných plechov na profilové nosníky



Vomet, spol. s r. o.
Trstínska cesta 19, 917 01 Trnava
Slovenská republika
www.vomet.sk

seit 1879



Príklady použitia so zaklinovanou kraiovou lištou

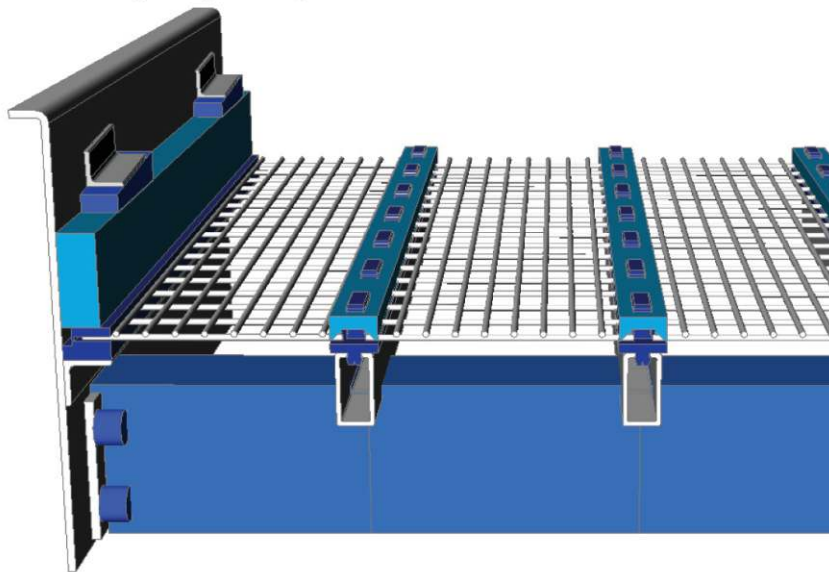

Kryt na adaptér



Adaptér na profilový nosník

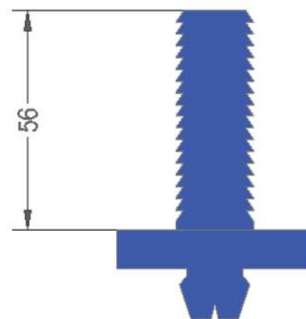
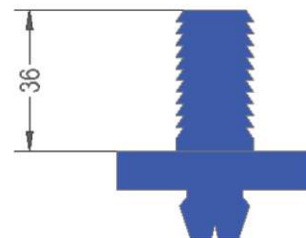

Kraiová lišta pri zaklinovanej stranovej lište



Príklady použitia so systémovou kraiovou lištou

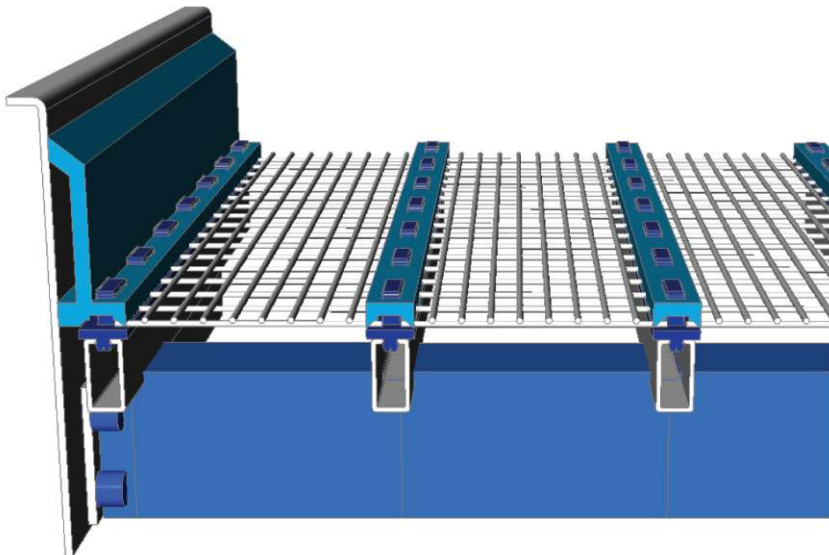

Výšky systémovej kraiovej lišty

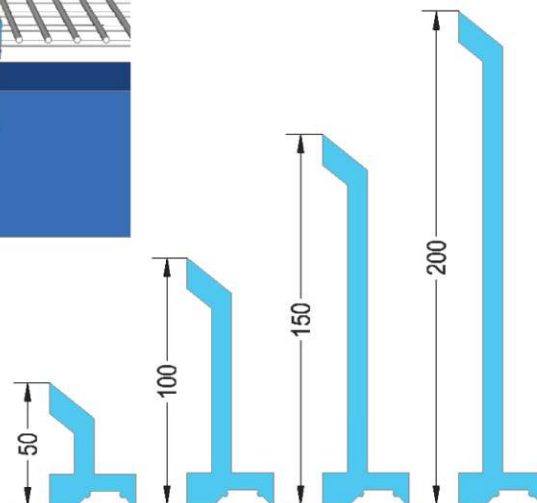

Napínané sitá a sitové panely z PU

Priečne a pozdĺžne napínané

Priečne napínané bez stredového upevnenia

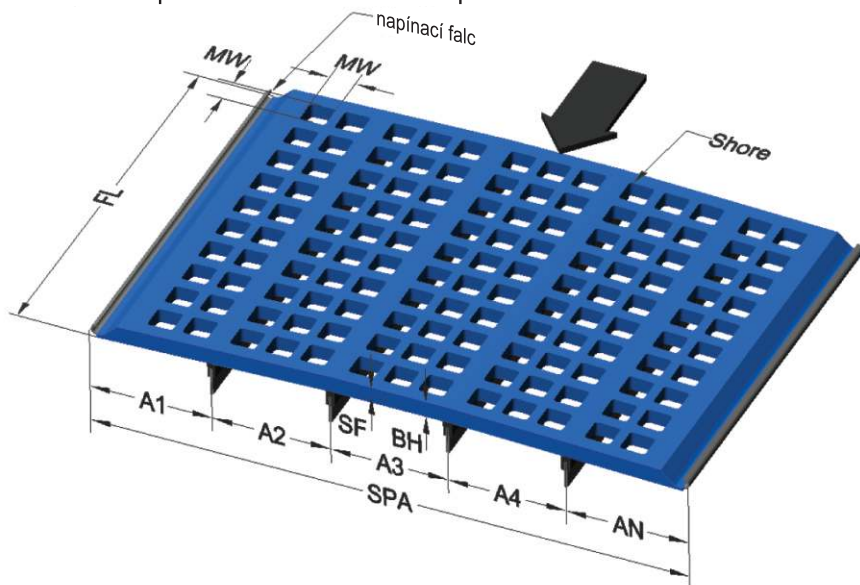

Legenda:

- SPA: napínací falc meraný zvonka
- FL: dĺžka falcu
- BH: hrúbka sita
- SF: hrúbka sitovej plochy
- MW: veľkosť oka
- A1/A2/.....: rozostup nosníkov
- Typ falca:
- Shore: stupeň tvrdosti (Polyuretan 55-90° Shore)

Priečne napínané so stredovým upevnením

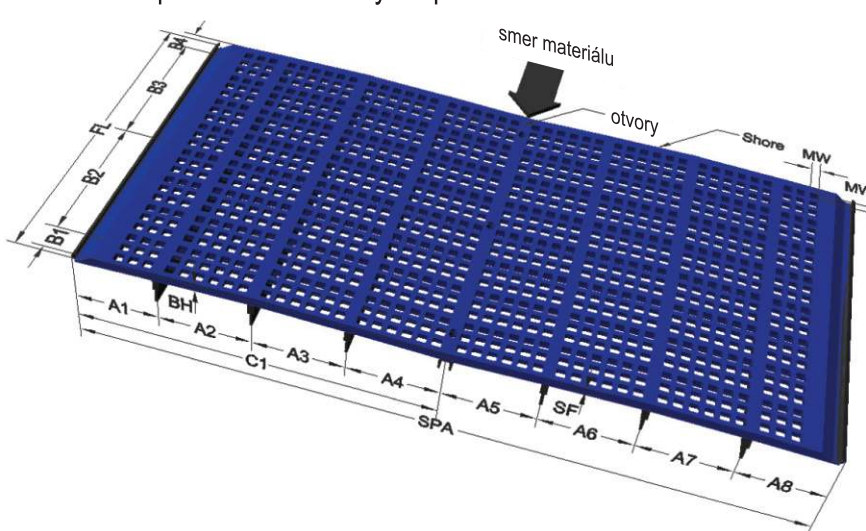

Legenda:

- SPA: napínací falc meraný zvonka
- FL: dĺžka falcu
- BH: hrúbka sita
- SF: hrúbka sitovej plochy
- MW: veľkosť oka
- A1/A2/.....: rozostup nosníkov
- B1/B2/.....: rozostup otvorov
- C1: rozostup otvorov
- Otvory: x mm upevňovacej lišty
- Typ falca:
- Shore: stupeň tvrdosti (Polyuretan 55-90° Shore)

Pozdĺžne napínané

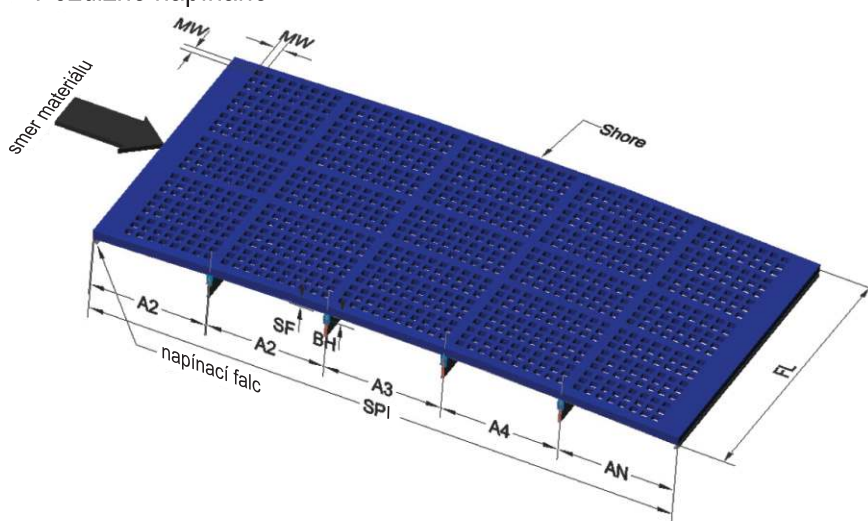

Legenda:

- SPI: napínací falc meraný vo vnútri
- FL: dĺžka falcu
- BH: hrúbka sita
- SF: hrúbka sitovej plochy
- MW: veľkosť oka
- A1/A2/.....: rozostup nosníkov
- Typ falca:
- Shore: stupeň tvrdosti (Polyuretan 55-90° Shore)

Rôzne rozmery a veľkosti na základe individuálneho dopytu.



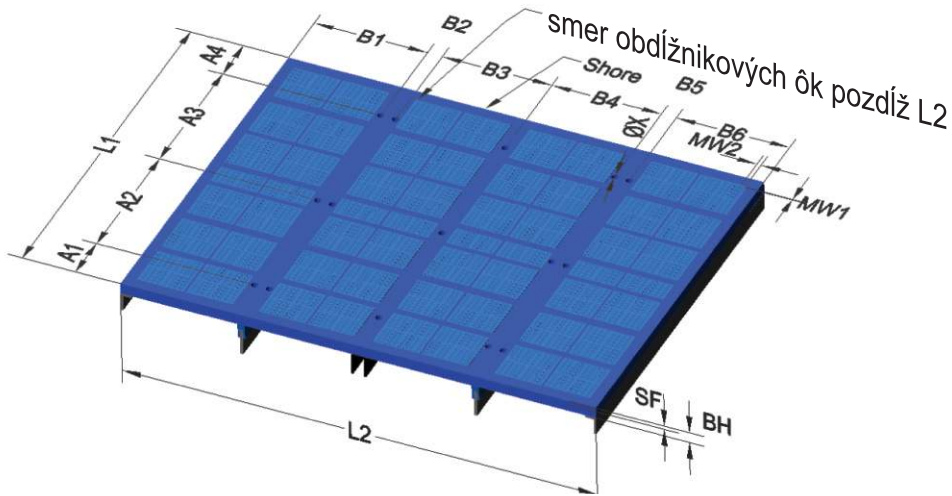

Legenda:

- L1: dĺžkový rozmer v mm
- L2: dĺžkový rozmer v mm
- BH: stavebná výška (hrúbka sita)
- SF: výška (hrúbka) sitovej plochy
- MW1: veľkosť otvoru
- MW2: veľkosť otvoru
- A1/A2: rozostup otvorov
- A1/A2/: rozostup otvorov
- C1: rozostup otvorov
- Otvory: _x_ upevňovacie otvory
- Obdĺžnikové oká: pozdĺž L
- Shore: stupeň tvrdosti (Polyuretan 55-90° Shore)



Prestavba priečne napínaných sit na modulárny systém

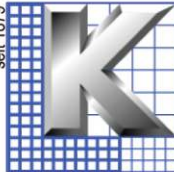

Pred prestavbou

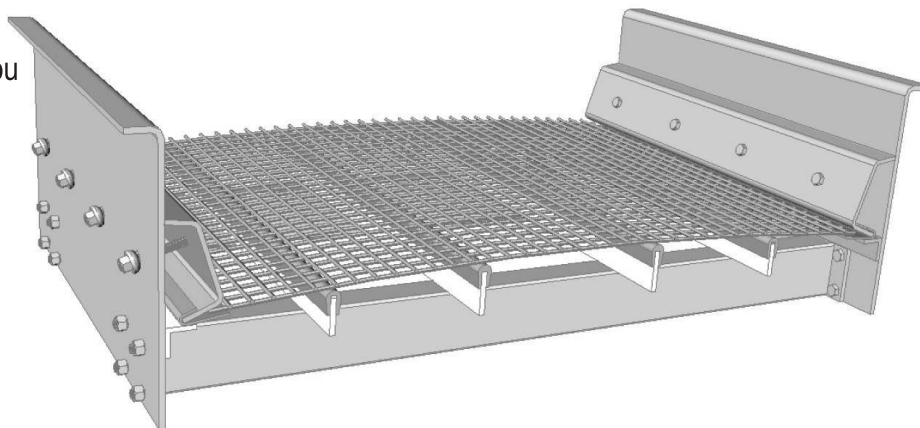

Prestavba

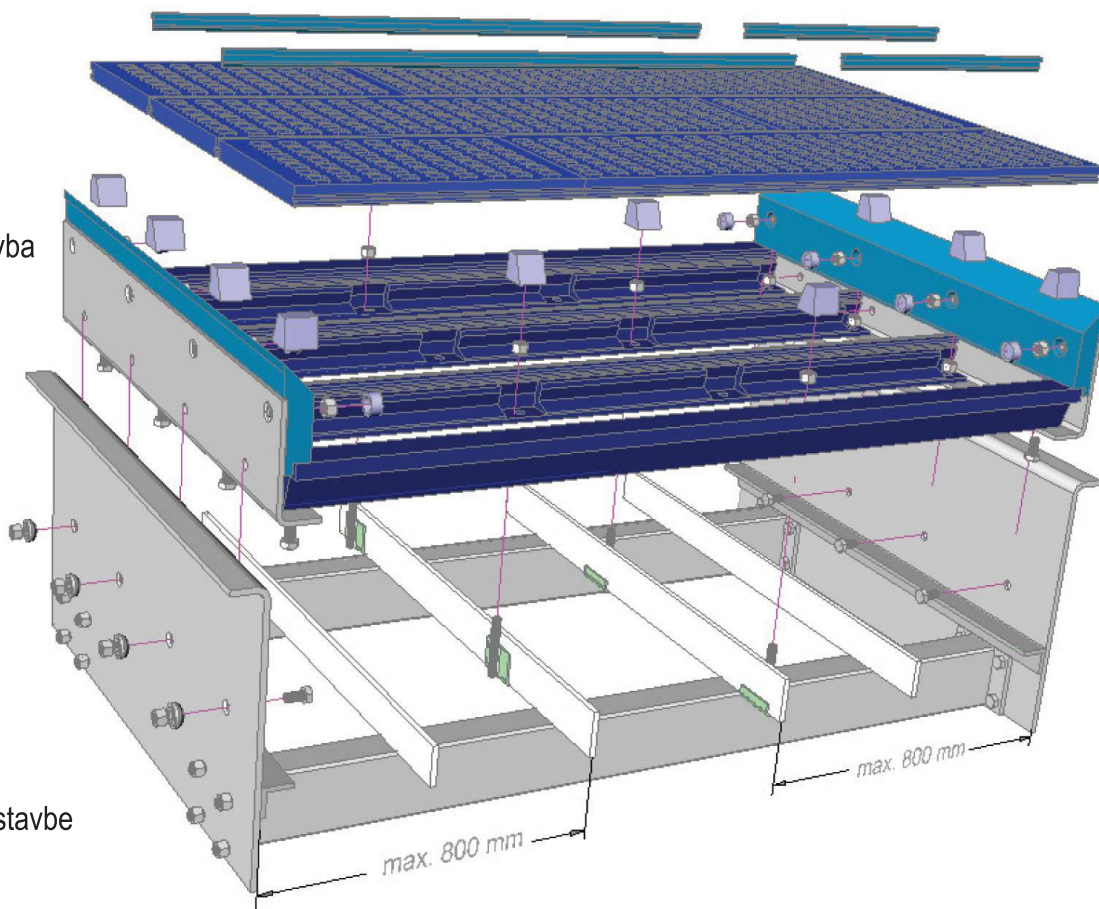

Po prestavbe

